



SSSF
SCHOLASTIC
SHOOTING SPORTS
FOUNDATION



2026

NATIONAL CHAMPIONSHIP



JULY 10TH - 18TH, 2026
CARDINAL SHOOTING CENTER | MARENGO, OHIO

“Brenda and I are proud to partner with the Scholastic Shooting Sports Foundation to support getting more kids involved in shooting sports today,” said Larry Potterfield, Founder and Chairman of the Board, MidwayUSA Office. “We strongly support initiatives like this because we believe we have an obligation to help change the future for the better.”

THANK
YOU!



MAKE A DIFFERENCE, KEEP THEM ON THE RANGE!



To begin your support of youth shooting sports, visit
www.sssfonline.org/donate

- Simple Donations
- Scholarship Funds
- Supporting Memberships
- Memorial and Legacy Donations



Scan to start your support today!

PRESIDENT'S LETTER

Welcome to the 2026 Scholastic Shooting Sports Foundation (SSSF) National Championships! On behalf of the SSSF Board of Directors, our staff, and the many volunteers who make this event possible, we are excited to welcome you back to the Cardinal Shooting Center for another outstanding year of competition, camaraderie, and achievement.

When this program went to press, more than 4,000 registered athletes were preparing to compete in over 13,000 individual entries. The continued growth and success of our youth development programs is a direct reflection of the dedication and enthusiasm of our athletes, parents, and volunteer coaches. Thank you for your commitment to the SCTP and SASP programs and for being an integral part of our community.

We also extend our sincere appreciation to our sponsors, donors, and industry partners. Their generous support helps make our programs and this championship possible. During your time at Nationals, please take a moment to visit Vendors' Row and thank the companies and organizations that invest in our athletes and programs. Vendors' Row is once again packed with great exhibitors and shopping opportunities. Be sure to stop by the SCTP/SASP store at B11/B12 for official event merchandise, including championship shirts and other commemorative items.

In addition to the week's competition events, we have several special activities planned. Join us Wednesday evening at the grandstand for the Opening Ceremony, featuring the parade of teams, recognition of our All-State athletes, and special guests Larry and Brenda Potterfield. It is always a memorable event and a great way to celebrate our athletes.

There will be plenty happening throughout the National Championships, and one of the best ways to stay informed is through our text messaging updates. Simply text SSSFNATIONALS to 877-617-6454 to receive important announcements and event information.

Whether this is your first National Championships or you are a returning participant, we hope you enjoy your time here. If you have questions or need assistance during the week, please reach out to our staff as we are here to help make your Nationals experience a memorable one.

Be sure to share your favorite moments on social media using #SCTPNationals2026, #SASPNationals2026 and #SSSFNationals2026.

Thank you for choosing to spend part of your summer with us at the Cardinal Shooting Center. The Cardinal Center team has worked hard to prepare for your arrival, and we are grateful for their partnership and hospitality. Most importantly, we appreciate your participation in our programs and your commitment to the future of the shooting sports.

Best of luck to all competitors. Shoot safely, compete with pride, and enjoy the experience!

Rick Leach
SSSF President & Executive Director

SCHEELS®



FROM PRACTICE PULLS TO PODIUM FINISHES

SCHEELS is proud to support the athletes, coaches, and families of the Scholastic Clay Target Program.
Keep crushing 'em.



To find a location near you, visit [SCHEELS.com/stores](https://www.scheels.com/stores)

Connect with us @scheelsoutdoors   

Shop Anytime Anywhere on [SCHEELS.com](https://www.scheels.com)

2026 SSSF NATIONALS TEXT UPDATES!

Sign up for our text messaging service to keep updated about current events, schedule changes, weather delays and other important news.

Simply text SSSFnationals to 877-617-6454 to opt in and you may opt out at any time. The service is free to use and will only be used for tournament information.

If you unsubscribed at any point from last year's texts, you will need to text "UNSTOP" to the same number to give us permission to text you again!

Standard messaging rates may apply.

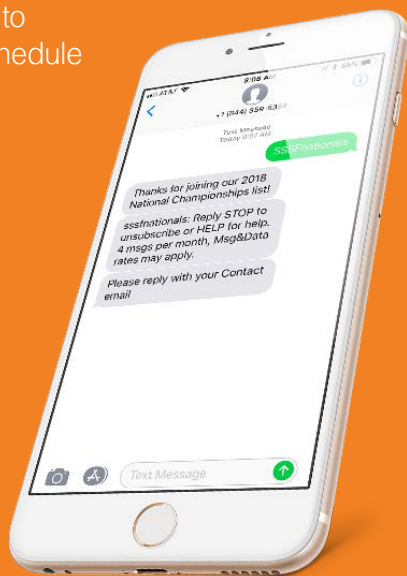

Look for this sign posted in tents and on vendor doors!



These businesses proudly sponsor & support YOUR sport, PLEASE patronize them whenever possible!

JOIN THE FIREARM SAFETY INITIATIVE WITH GLOCK®

KNOW AND REMEMBER THE FOUR RULES OF GUN SAFETY

1.



TREAT ALL FIREARMS AS IF THEY ARE LOADED

2.



NEVER POINT THE MUZZLE AT ANYTHING YOU ARE NOT WILLING TO DESTROY

3.



KEEP YOUR FINGER OFF THE TRIGGER UNTIL YOUR SIGHTS ARE ALIGNED ON THE TARGET AND YOU ARE READY TO FIRE

4.



ALWAYS BE SURE OF YOUR TARGET AND WHAT'S BEYOND IT



TAKE THE PLEDGE
GLOCKSAFETY.COM



TABLE OF CONTENTS

| | |
|---|--------|
| A Thank You to the Potterfields | 1 |
| President's Letter | 3 |
| Text Message Updates & Proud Sponsors | 5 |
| Venue Map | 9,10 |
| Staff List | 12 |
| SCTP National Team Championships | |
| Schedule of Events | 13,14 |
| SCTP Tournament Info. & Guidelines | 15 |
| Appeals Committee, Events, Awards | 17 |
| SCTP Side Games and more..... | 20 |
| SASP National Team Championship | |
| Schedule of Events..... | 31, 32 |
| SASP Event & Walker's HOA Awards..... | 33 |

| | |
|---|-------------|
| Top Gun Challenge..... | 36 |
| SCTP Nationals Shooting Scholarships..... | 39 |
| SSSF Academic Scholarships..... | 47, 48 |
| Camping..... | 53 |
| Ammunition & Golf Cart Rules..... | 57 |
| Directions..... | 57 |
| Additional Guidelines for SCTP & SASP | 61 |
| SCTP Sponsors..... | 65, 66 |
| SASP Sponsors..... | 69, 70 |
| SASP Stages..... | 71,75,79,81 |
| 2025 SSSF All-Scholastic Team..... | 87, 88, 89 |

ADVERTISER INDEX

| | |
|----------------------------------|------------|
| ACUI..... | 63,64 |
| Alpen Optics..... | 73 |
| ATA..... | 34 |
| AXIL..... | 105 |
| Baron Engraving..... | 105 |
| Beretta..... | 16,46 |
| Blackwing Shooting Center..... | 99 |
| Blue Rock Coaching..... | 24 |
| Birchwood Casey..... | 90 |
| Boss LLC | 38 |
| Briley..... | 19 |
| Browning..... | 42,52,102 |
| Cardinal Shooting Center..... | 102 |
| Caesar Guerini..... | 8 |
| CCI..... | 94 |
| Cole Gunsmithing..... | 100 |
| CZ..... | 91 |
| Dawson Enterprises..... | 104 |
| Ducks Unlimited..... | 101 |
| Fabarm | 8 |
| Federal | 59,86 |
| Fiocchi..... | 58 |
| GAIM | 32 |
| GLOCK..... | 6 |
| The Great Outdoors Company | 67 |
| GPS..... | 83 |
| GT Target Stands..... | 68 |
| GunBroker.com..... | 102 |
| Guns Unlimited | 103 |
| Hodgdon Powder..... | 49,92, 98 |
| HugeX Arms..... | 92 |
| Hunters HD Gold..... | 83 |
| Hornady..... | 96 |
| Junior Shooters | 23 |
| Kolar | 40 |
| Laser Shot..... | 92 |
| LevelFive..... | 54 |
| Magpul..... | 93 |
| Make A Break..... | 26, 27, 28 |

| | |
|--|--------|
| Mantis X..... | 82 |
| Megalink..... | 93 |
| MEC..... | 25 |
| MidwayUSA..... | 37,83 |
| MOS Manufacture..... | 58 |
| Mossberg..... | 60 |
| Negrini..... | 68 |
| Next Level Training..... | 22 |
| Pardini USA..... | 95 |
| Prairie Grove Shooting Sports Complex..... | 107 |
| Promatic..... | 62 |
| Remington..... | 45 |
| Rhino Chokes..... | 68 |
| RUGER..... | 29,41 |
| Rural 1st..... | 95 |
| SCHEELS | 4 |
| SigSauer..... | 76 |
| Silencer Central..... | 90 |
| SK Ammunition..... | 51 |
| SKB..... | 21 |
| Sportsman's Den..... | 30 |
| Steel Target Paint..... | 83 |
| Syren..... | 51 |
| Tactical-Grit..... | 83 |
| Take Aim Technologies..... | 110 |
| TandemKross | 84 |
| Taurus..... | 56 |
| TETRA | 18 |
| Tippmann Arms..... | 55 |
| TruGlo..... | 93 |
| Ultimate Shooting Accessories | 35 |
| Volquartsen | 67 |
| Vortex..... | 78 |
| Walker's | 11 |
| White Flyer | 43 |
| Winchester | 44, 50 |
| Winchester Repeating Arms..... | 42 |
| Winchester Safes..... | 105 |

CAESAR GUERINI

COMPETITION GUNS BUILT FOR FUTURE CHAMPIONS

At Caesar Guerini, we offer more competition shotguns designed for up-and-coming competitors than any other company. We focus on giving youth shooters the tools they need to be successful without having to take out a second mortgage. Come visit us at our booth and demo our guns to learn more about how Caesar Guerini helps young shooters excel at their sport.



SUMMIT TRAP COMPACT



SUMMIT SPORTING COMPACT

(410) 901-1131 GUERINIUSA.COM



FABARM
100% MADE IN ITALY. SINCE 1900

ONE SHOTGUN FOR MULTIPLE DISCIPLINES



**ELOS N2
ALLSPORT**

**DEMOS
AVAILABLE**

The Elos N2 Allsport is an incredibly versatile shotgun. It is designed for shooters who want one gun that can be configured for various styles and disciplines. Whether you shoot Sporting Clays, FITASC, Skeet or Trap – The Elos N2 Allsport has you covered. Stop by and demo one today and ask about all of the features that make this gun an outstanding value for SCTP shooters!

410.901.1260

FABARMUSA.COM

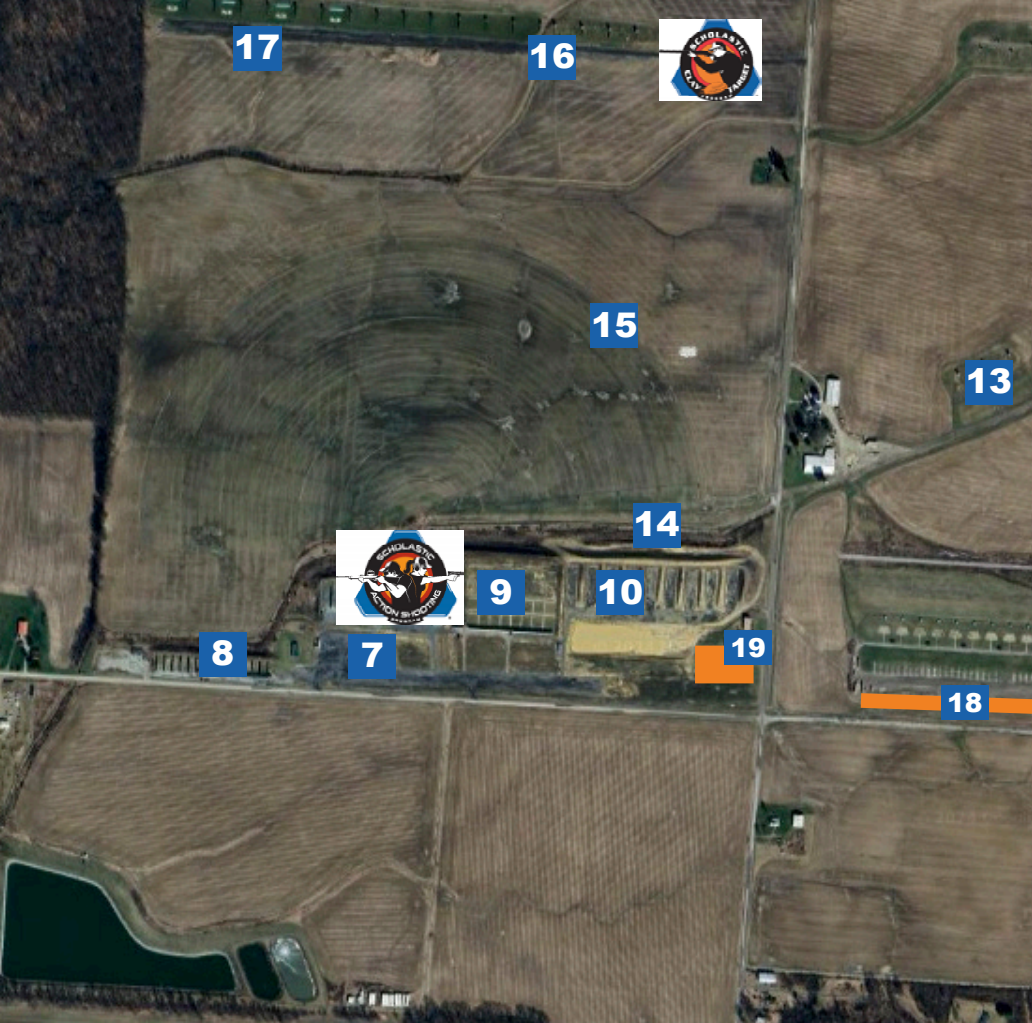

1. Central Events Building (**CEB**):
SCTP Registration, MidwayUSA Foundation
2. Grandstands, **Trap Practice** Hut
3. SCTP/SASP Vendor Row
4. **Golf Cart Rentals**: Small White Trailer located BEHIND **CEB**
5. Campground Office/Hitters Building: **College Day** (17th)
6. SASP Action Shooting Awards, Banquet Hall
7. **SASP Registration**, Action Shooting Bays Range 2,
 MidwayUSA Foundation
8. Action Practice bays Range 1, Side Matches, Sponsor Demos
9. SASP Range 3
10. SASP Range 4
11. Sporting Clays Lodge, Open Make-A-Break



UTVs are not permitted to remain in main parking lots overnight. Please park them with your trailer each evening.

If your campsite borders a parking lot, please keep all vehicles, trailers, equipment, and other items within your assigned campsite. Overflow into parking areas, including reserving or blocking parking spaces, is not permitted.

- 12. Make-A-Break: Squads & Finals
- 13. **Skeet Field 19,20**
- 14. Sporting Practice
- 15. **Super Sporting** Clays and **5 Stand** courses
- 16. **Skeet Fields 1-18**
- 17. International Fields
- 18. Trailer Parking
- 19. Trailer Parking
- 20. Trailer Parking

Trailers must be parked in designated trailer parking areas only. Trailer parking is not permitted in the main parking lots. Any trailers parked in unauthorized areas may be towed at the owner's expense. Please review the event map and plan accordingly. Thank you for your cooperation.



WALKER'S®



RECON™

PROFESSIONAL GRADE **DIGITAL MUFF**



DIGITAL CIRCUIT



TACTI-GRIP AIR™
HEADBAND



IPX4 WEATHER
RESISTANT



INTEGRATES
SEAMLESSLY WITH
RECON™
WALKIE TALKIE
SOLD SEPARATELY

- BLUETOOTH® 5.0 INTEGRATED CONNECTIVITY
- DIGITAL MEM LOW NOISE MICROPHONES DELIVERS CLEAR SOUND
- FULL DYNAMIC RANGE HD SPEAKERS FOR CLEAR
- BALANCED SOUND
- PUSH BUTTON DIGITAL VOLUME CONTROL FOR PRECISE SOUND ADJUSTMENT
- SPLIT SECOND SOUND ACTIVATED COMPRESSION
- TACTI-GRIP AIR™ - HI-PERFORMANCE SILICONE COMPOSITE HEADBAND
- SOUND DAMPENING COMPOSITE HOUSING WITH BONDED RUBBER COATING
- 3.5MM AUDIO JACK

WALKERSGAMEEAR.COM

STAFF

Scholastic Shooting Sports Foundation

Rick Leach - President & Executive Director
Brad Fleury - Director of Operations
Kris Leach - Executive Assistant
Belinda Jones - Bookkeeper
Amber Meyer - Marketing and Communications Specialist
Holly Haigh - Compliance and Inventory Manager

SCTP National Staff

| | |
|---------------------------------------|---|
| Wayne Rasmussen - National Director | Jason Anderson - SW Programs Manager |
| April Carr - Administrative Assistant | Hank Garvey - Regional Field Rep, NE Region |
| Darin Riggleman - NE Programs Manager | Terri Wentzel - International Team Head Coach |
| Jeff Morrison - NW Programs Manager | |
| Sylvia McCart - SE Programs Manager | |

SASP National Staff

John Leach - National Director
Kris Leach - Executive Assistant
Chris Albertson - Programs Manager - Action Shooting
Bill Perkins - Regional Field Rep, Southwest Region

Board of Directors

| | |
|---|------------------------------------|
| Ed Fitzgerald - Chairman | Ernest Myers |
| Chris Hodgdon - Vice Chairman | Jack Parker |
| Brad Mendenhall - Budget/Finance Chairman | Jen Ramsay |
| Paul Pluff - Treasurer | Bernie Till |
| Nathan Boyd - Secretary | Major General Paul Knapp (Retired) |
| | Sean Mainland |

Tournament Directors

Wayne Rasmussen - SCTP
John Leach - SASP

SCTP INTERNATIONAL SCHEDULE OF EVENTS

Tuesday, July 7 - Presented by Ceasar Guerini

9:00am SQUADED Training - International Trap & International Skeet
12:00pm - 5:00pm Check-In & Registration at International Fields

Wednesday, July 8 - Presented by SKB

9:00am International Skeet 75 Target Competition
9:00am International Trap 50 Target Competition
9:00am - 5:00pm Check-In & Registration at International Fields

Thursday, July 9 - Presented by MEC

9:00am International Skeet 50 Target Competition followed by Match Finals & Awards
9:00am International Trap 50 Target Competition

Friday, July 10 - Presented by Castellani USA

9:00am International Trap 25 Target Competition followed by Match Finals & Awards

***True to the International disciplines, squads are chosen at random and squad times and flights will vary depending on total number of participants. This is an actual International event in all aspects, not a practice or try it type event. The SCTP International Team will be chosen from the finalists of this event.**

SCTP SCHEDULE OF EVENTS

Saturday, July 11 - Presented by Fiocchi

7:30am - 5:00pm Check-In and Registration
8:00am 1st 100 of Saturday/Sunday Skeet, Trap Doubles, Handicap, Sporting Clays Rotation
Squadded Make-A-Break
**Make-A-Break Walk-ons available for athletes, coaches and spectators, separately at the Make-A-Break at Sporting Clays throughout Nationals*

Sunday, July 12 - Presented by Kolar

7:30am - 5:00pm Check-In and Registration
8:00am 2nd 100 of Saturday/Sunday Skeet, Trap Doubles, Handicap, Sporting Clays Rotation
Squadded Make-A-Break

Monday, July 13 - Presented by Promatic

7:30am - 5:00pm Check-In and Registration
8:00am 1st 100 of Monday/Tuesday Skeet, Trap Singles, Trap Doubles, Handicap, Sporting Clays,
Super Sporting Clays
11:00am - 5:00pm Squadded Make-A-Break
Games - Stores Open

SCTP SCHEDULE OF EVENTS

Tuesday, July 14 - Presented by SCHEELS

- 7:30am - 5:00pm Check-In and Registration
- 8:00am 2nd 100 of Monday/Tuesday Skeet, Trap Singles, Trap Doubles, Handicap, Sporting Clays, Super Sporting Clays
- 11:00am - 5:00pm Squadded Make-A-Break Games - Stores Open

Wednesday, July 15 - Presented by MidwayUSA Foundation

- 7:30am - 5:00pm Check-In and Registration
- 8:00am 1st 100 of Wednesday/Thursday Skeet, Trap Singles, Trap Doubles, Handicap, Sporting Clays, Super Sporting Clays
- Squadded Make-A-Break
- 9:00am 5-Stand Charity Shoot Open - 100 Targets - WEDNESDAY OR THURSDAY
- 11:00am - 5:00pm Games - Stores Open
- 5:00pm **All Industry Opening Ceremonies, States/Teams Parade - Grandstands | Line up for parade starts at 4:30p**
- **Last Competitor Standing will start 15 minutes after the conclusion of Opening Ceremonies and is a \$10 entry fee**

Thursday, July 16 - Presented by Beretta

- 7:30am - 5:00pm Check-In and Registration
- 8:00am 2nd 100 of Wednesday/Thursday Skeet, Trap Singles, Trap Doubles, Handicap, Sporting Clays, Super Sporting Clays
- Squadded Make-A-Break
- 9:00am 5-Stand Charity Shoot Open - 100 Targets - WEDNESDAY OR THURSDAY
- 11:00am - 5:00pm Games - Stores Open
- 5:30pm Pizza Party at CEB Pavilion
- 6:00pm Make-A-Break Team Shootoffs

Friday, July 17 - Presented by Winchester

- 7:30am - 4:00pm Check-In and Registration
- 8:00am 1st 100 of Friday/Saturday Skeet, Trap Singles Skeet Doubles
- 9:00am Sporting Clays Charity Shoot Open - 100 Targets - FRIDAY OR SATURDAY
- 9:00am - 4:00pm College Day at the Hitters Building
- 11:00am - 5:00pm Games - Stores Open
- ~ 6:00pm **Skeet, Sporting Clays, Super Sporting Clays Shoot Offs followed by Awards at Grandstands**

Saturday, July 18 - Presented by Browning

- 8:00am 2nd 100 of Friday/Saturday Skeet, Trap Singles
- 9:00am Sporting Clays Charity Shoot Open - 100 Targets - FRIDAY OR SATURDAY
- 11:00am - 5:00pm Games - Stores Open
- ~ 5:00pm **Make-A-Break Individuals Shoot Off at Grandstands**
- ~ 6:00pm **Trap Shoot Offs followed by awards at Grandstands for Skeet Doubles, Trap, Trap HOA and overall HOA Awards**

SCTP TOURNAMENT INFORMATION & GUIDELINES

Skeet Practice/Location/Price

July 7th -10th sign up at the Sporting Clays Building

Practice will be open on the two fields by sporting clays and the first four fields on the big line until skeet competition starts on the 11th.

Open: 12:00pm - 5:00pm ****Practice times subject to change****

\$9.00 / 25 Targets

Sporting Clays Practice/Location/Price

July 12th -15th sign up at the Sporting Clays Building

Open: 7:00am - Dusk ****Practice times subject to change****

\$0.50 / Target

Trap Practice/Location/Price

July 8th -17th sign up at the practice hut next to the Grandstands

Open: 7:00am - Dusk ****Practice times subject to change****

\$8.00 / 25 Targets

Anyone wishing to practice Skeet or Trap on days that are not available at the Cardinal Center, can do so at the Black Wing Shooting facility, our official practice range. Information available on page 99.

Adult/Coach supervision required to purchase practice rounds and while shooting.

****Driver's License is required to purchase practice keys. License will be held on file until practice key is returned.****

Registration

Head Coaches/Designated Coaches must check in at the Central Events Building, verify their team entry and squadding information, and pick up their Shoot Packets in person. All coaches will be required to sign off on their team's squadding, verifying that all squads and divisions are correct! Team and athlete event registration fees may be refunded through July 1st.

Divisions and Categories:

Rookie - 5th Grade and under

Intermediate Division / Entry - 6th to 8th Grade (First Year Competing as Intermediate)

Intermediate Division / Advanced - 7th and 8th Grade

Senior Division / Junior Varsity - 9th to 12th Grade (First Year Competing in Senior Division)

Senior Division / Varsity - 10th to 12th Grade

Collegiate - Athletes must have been enrolled as full time students in an accredited college/university during the 2025-26 school year.

Shoot Off Procedure:

Shoot off procedure is listed in the handbook. The only shoot offs will be for perfect scores or HOA ties. Athletes and Coaches will be notified through the text system if they are needed for a shoot off.

Note:

Shoot times will be strictly enforced. Please do not waste time in between rounds, and NO coaching is allowed during or between rounds.

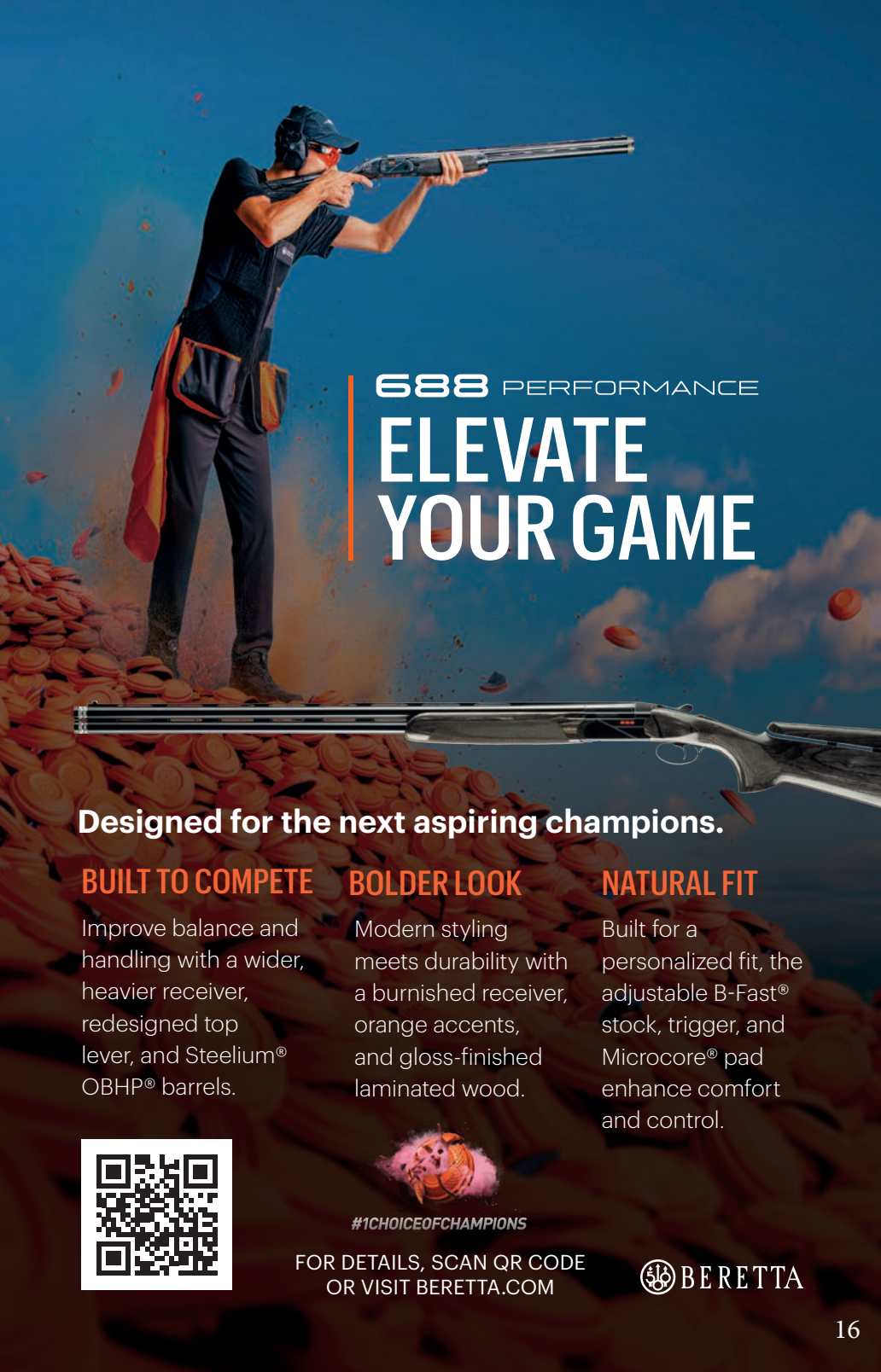

688 PERFORMANCE

ELEVATE YOUR GAME

Designed for the next aspiring champions.

BUILT TO COMPETE

Improve balance and handling with a wider, heavier receiver, redesigned top lever, and Steelium® OBHP® barrels.

BOLDER LOOK

Modern styling meets durability with a burnished receiver, orange accents, and gloss-finished laminated wood.

NATURAL FIT

Built for a personalized fit, the adjustable B-Fast® stock, trigger, and Microcore® pad enhance comfort and control.

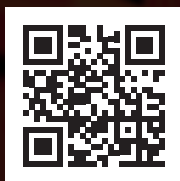

#1CHOICEOFCHAMPIONS

FOR DETAILS, SCAN QR CODE
OR VISIT BERETTA.COM



APPEALS COMMITTEES

TRAP

Rob Kinsella-OH
Tina Marshall-OH
Gene Roeder-WI
Jennifer Laurent-MO
Matthew Jendrusina-AK

SPORTING CLAYS

Wendell Mixon-FL
James LeBlanc-TX
Zac Guerrettaz-GA
Phil Wilgus-MA
John Wojtas-GA

SKEET

Bill Saylor-MI
Jordan Hintz-MI
Lisa Holtkamp-FL
Joel Dinkins-NC
Eric Duld-KS

SCTP EVENTS AND AWARDS

Main Event (Trap, Skeet & Sporting Clays)

Team Championships/Team Awards - Division/Category 1st - 5th | Collegiate 1st - 3rd
Team scores will comprise of the top 5 scores for Trap and top 3 scores in Skeet and Sporting Clays per Division/Category.

Individual Awards (Trap, Skeet, Sporting Clays & HOA Awards)

Individual Men - Division/Category 1st - 5th | Collegiate 1st - 3rd
Individual Ladies - Division/Category 1st - 5th | Collegiate 1st - 3rd

Concurrent Events (Trap, Skeet & Sporting Clays)

High School Team Division 1st - 5th

**High School Division teams must have supplied a letter from their school verifying all Senior Division athletes on the team roster attend that school.

PLEASE NOTE: The concurrent "High School Division Awards" will also be determined by team scoring. Team scoring will be comprised of the top 5 scores in the Senior Division (Varsity & JV combined) for Trap, top 3 for Skeet and top 3 for Sporting Clays.

SCTP HOA TEAM AWARDS

Main Event (Trap, Skeet & Sporting Clays) 1st - 5th

Main event HOA determined by a team's top 5 scores in Trap, top 3 scores in Skeet and top 3 scores in Sporting Clays excluding Collegiate classification.

The High School Team HOA award will utilize the top 5 scores in the Senior Division (Varsity & JV combined) for Trap, Skeet, and Sporting Clays

**High School Division teams must have supplied a letter from their school verifying all Senior Division athletes on the team roster attend that school.

OTHER EVENTS

Doubles Trap, Handicap Trap, Double Skeet, Super Sporting Clays

Awards for 1st - 3rd place Team Plaques/Medals and Individual Medals 1st - 3rd for Men and Ladies per Division

5 Stand

Will have ammo prizes as team awards for 1st - 3rd in Intermediate and Senior Divisions only, no individual awards.

Handicap Trap

Rookie Squads shoot at 19 Yard

Intermediate Squads shoot at 21 Yard

Senior Division Squads shoot at 25 Yard (all college squads will also shoot from here)

Mixed Division Squads will ALL shoot at the furthest squadded athlete on that squad

HEARING ~~PROTECTION~~ PERFECTION



TETRA

HEARING™



LEARN MORE

WWW.TETRAHEARING.COM



FIVE DECADES OF EXCELLENCE. ONE ENDURING STANDARD.
TRUSTED BY SHOOTERS FOR 50 YEARS AND COUNTING...
A LEGACY OF SHOOTING INNOVATION CONTINUES.



BRILEY
A Legacy of Shooting Innovation.

WWW.BRILEY.COM
1230 LUMPKIN RD., HOUSTON, TX, 77043
1-800-331-5718



TARGET FEES

Skeet Doubles - 100 targets - \$65 per athlete
Handicap Trap - 200 targets - \$110 per athlete
Trap Doubles - 200 targets - \$110 per athlete
Trap - 200 targets - \$115 per athlete *(includes ATA registered target fees)
Skeet - 200 targets - \$115 per athlete *(includes NSSA registered target fees)
Sporting Clays - 200 targets - \$145 per athlete *(includes NSCA registered target fees)
Super Sporting Clays - 100 targets - \$80 per athlete
International Trap - 125 targets - \$135 per athlete
International Skeet - 125 targets - \$135 per athlete
5 Stand - 100 targets - \$65 per athlete
Make-A-Break Team Event - \$20 per athlete

SIDE GAMES / ACTIVITY DETAILS

“Make-A-Break” (Two Athlete) - \$15 per athlete
Daily ammunition prizes. Top daily individual winners will shoot off on Saturday around 5PM for prizes and awards for Top Lady and Top Guy. The overall winner will walk away with a Beretta A400XCEL!

PIZZA AND SODA PARTY

THURSDAY | 5:30PM | CEB PAVILION

Free pizza and beverages while supplies last!

Compliments of:



COLLEGE RECRUITING MEET & GREET

FRIDAY | 9:00AM - 4:00PM

at the “Hitters Building” next to the campground office!

Meet colleges with shooting sports programs
and learn about shooting sports scholarship opportunities!

HTR

HIGH TRAP RIB



SKB



IMPROVE YOUR PISTOLCRAFT



PRACTICE MAKES PERFECT

Assessing the situation, acquiring a target, drawing from under a jacket, and taking the shot is a learned skill.



SITUATIONAL AWARENESS

Assessing an environment takes training. Practice Situational awareness in the privacy of your own home.



KNOWLEDGE IS POWER

Keep the kids safe from accidents firearm safety. The SIRT is a perfect educational tool.



SHARPEN YOUR SKILLS

Train like a professional. SIRTs are designed and rigorously tested by one of the world's best shooters.



RESPONSIBILITY. ACCOUNTABILITY. SAFETY.

A SIRT gives you and your loved ones the opportunity to train and make mistakes without repercussion.



FOR THE BEGINNER

Carrying a weapon can be awkward. A SIRT is perfect if you're new to carrying and trying get comfortable.

WHICH SIRT FITS YOU?



107



110



POCKET PISTOL



SIRT 20



SIRT 20C



More info at:
www.nextleveltraining.com

JUNIOR SHOOTERS Magazine, SCTP & SASP

Want your article!



You could be in the next issue!

Caledon Shotguns

For Bob

magazine does for the junior shooters out there and hope that I can continue to get permission shooting for the future. About six months ago I had a pair of SAUCO Canadian Gun and Order (CAG) shotguns for \$9 each, a 12 gauge and a South Model 20 gauge. I have since shot both many times and have really enjoyed doing so. The standard 12 gauge model features a 34 1/2" length of pull, automatic, ejector, magazine feed, and a single selector knob. The highest quality Turkish wanted is meticulously shaped, oiled, and hand finished to perfection. All models are offered in a 27", 28", or 30" barrel. The 12 gauge model weighs 7.25 pounds, while the 20 gauge weighs a modest 6.5 pounds. The Caledon features well on opening clay courses and comes well in the field. Many classic and timeless qualities make the Caledon unique among others in the field. The Youth Caledon has a barrel length of 27", a 12 1/2" length of pull and weighs only

hand and very steady. The birds like it where they think there are safe from bullets, which is really nice from my angle. Loaded the 12 gauge and absolutely loved it! It was great for the difficult terrain. Before you take off the long and use all your energy to get to where you want to be, which is at the top of the bank, you want your gun to perform flawlessly. The 12 gauge passed with flying colors.

Ease of assembly: The two 12 gauge were a snap to put together and came apart equally fast had a very tight action. A tight action is important if you want your gun to last a long time, which these guns will.

How it felt in my hands: The guns felt great in my hands, and I really enjoyed shooting them both. The 12 gauge fit me perfectly and shot right where I wanted it to. It was really smooth to shoot and easy to swing in a moving bird or target. The barrel was just long enough that you wouldn't miss anything

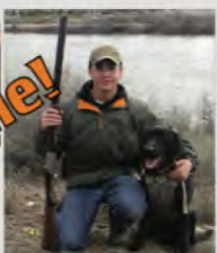

This could be your article!

upland birds and had great success with both of them for a day of pleasant hunting with my friends. One of the hunting was very successful, and I had a very nice day. One of the things that I really enjoyed about the hunt was that the birds were so close that I could see them clearly. I was really happy that they would be so close to me. I was really happy that they would be so close to me. I was really happy that they would be so close to me.

Another great aspect of these guns is the versatility. You could use them for almost anything. From the clay disciplines (opening clay, short trap) to game game, even to waterfowl, they are an all-around great gun. I took the 20 gauge hunting many times for quail and doves and loved using it. Both guns were so beautiful and at the same time rugged and reliable.

The promise of happiness for a shotgun is shorter hunting, it is probably the most challenging form of land hunting, but also the most rewarding. Chucker is other

short enough that it could be swung quickly to get a fast-moving object. The weight was not too heavy. It was nice to carry around all day. The 20 gauge was also fun to shoot. It was really smooth to shoot and easy to swing in a moving bird or target. The barrel was just long enough that you wouldn't miss anything

Right: Each gun had a huge brass bead at the end of its barrel which was great. You could see birds and targets with great ease. The field of view was enough that you could see where you were shooting and the target at the same time. I would not change the sight picture at all.

Beats: The most was noticeable but manageable. Both light target loads and heavy game loads were fine to shoot through the gun, and with the interchangeable chokes tubes, you could adjust the pattern of the gun if you wanted to.

Safety: The guns had a safety on the top of the receiver: it was a mechanical safety, so you have to turn it off every time you close the gun. This is great for land hunting, which are what these guns are really made for, but not so much for shooting clay targets. The safety was easy to get to and turn off when it was time to shoot.

These guns were great, and I would not change anything about either of them. They were awesome in every respect, and had a blast trying them out!

Thanks again, Junior Shooters, for allowing me to write an article for you.

CAPTIONS

1. Junior Caledon shotguns have tight action and are available in a Youth Model (see shotgun) or well as adult size.

2. The Junior Caledon is hand engraved and operates smoothly.

3. The engraving on the left side of the receiver adds a nice touch of elegance to a very functional hunting shotgun.

4. Posing with his dog and the Caledon 12 gauge had hunting pleasure.

5. The view of the receiver shows the beautiful engraving and the close detail to wood (L).

6. The bottom of the receiver and trigger guard are expertly engraved.

(1)

(2)

(3)

(4)

(5)

(6)

www.faulti-usa.com

Volume 1 / October 2011

Call 208-629-8967 or email editor@juniorshooters.net

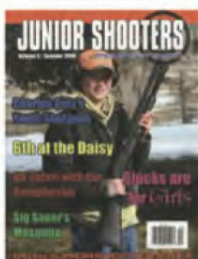

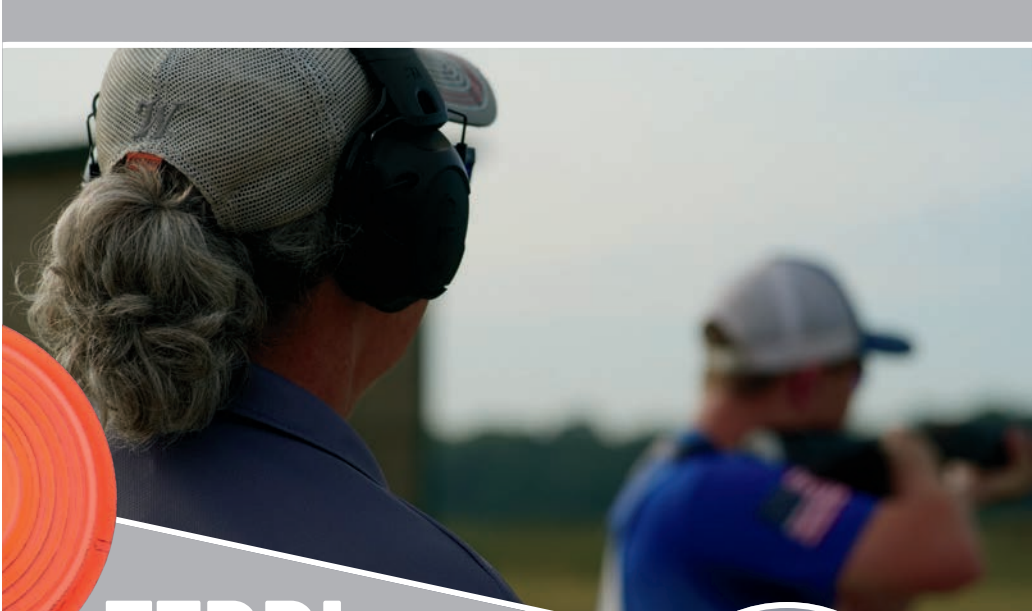

TERRI WENTZEL

Instructor - International Disciplines

SCTP TEAM COACH

Take your shooting skills to the next level with professional coaching designed to develop technique, mindfulness, and confidence on the field.



706.888.4016

bluerockcoaching@icloud.com



**BLUE ROCK
COACHING, LLC**



OUTDOORS



AMERICAN MADE FOR OVER 65 YEARS

From the reloading bench, to the field, MEC Outdoors is with you.



2026 SCTP



Make-A-Break® NATIONAL TEAM CHAMPIONSHIP

Thursday, July 16th at 6:00pm

TOP 8 QUALIFYING TEAMS (4 from each qualification field)

› HEAD-TO-HEAD › BEST OF 3 GAME FORMAT

WINNING TEAM RECEIVES:

RAY FORMAN TROPHY
Make-A-Break
SCTP NATIONAL TEAM CHAMPIONS

- 10 Flats of FEDERAL Ammunition
- 5 BROWNING Signature Range Bags, Gun Cases, Shooter's Towels
- 5 \$100 RHINO CHOKES Gift Certificates and Swag

RUNNER-UP:

- 10 Flats of FEDERAL Ammunition
- RHINO CHOKES Swag

(Prize packages subject to availability)

Details on how teams will participate can be found at:
Website: mysctp.com - Facebook & Instagram: [officialmakeabreak](https://www.instagram.com/officialmakeabreak)

TEAM COACHES CAN REGISTER ON THE SCTP SHOT SYSTEM



SCTP

Make-A-Break[®] NATIONAL TEAM



2026 CHAMPIONSHIP FORMAT

To highlight the relationship between the coach, the players and amongst the players themselves, here is how a Coach and Players Team work together in a Best-of-Three game MATCH:

1. The two Team Coaches in a match come to the *Make-A-Break* stages with their 5 players
2. The referee flips a coin and selects a coach, who then calls the flip. If the coach wins, she/he has the choice of putting up their first 2 players, OR making the other coach put up their first 2 players. This determines which stage a team shoots from (left or right) and which team starts the game - left side always shoots first
3. In the first half of each game and prior to commencing, each Team Coach chooses a player to shoot even numbered targets and the other to shoot odd numbered targets. In the second half the coach chooses the target numbers for each player as well:
 - a. There are 10 pairs of targets in a round, with 6 pairs in the first half and 4 pairs in the second half
 - b. Each team player must shoot at 3 pairs in the first half and 2 pairs in the second half of each round
 - c. Team players shoot their pairs alternately with each other
 - d. Coaches are responsible for getting their players on and off the stage and in the correct position
 - e. Each coach is responsible for watching the scoreboard and understanding the game and the number of points needed to win
4. The teams swap stages and now each coach selects 2 different players from the remaining 3 and shoots Game Two in the same format as Game One

SCTP



Make-A-Break[®] NATIONAL TEAM CHAMPIONSHIP



2026 QUALIFYING SCORES

Here is the format SCTP Team Coaches must follow for the official 2026 *Make-A-Break* TEAM CHAMPIONSHIP event:

1. Teams must register with the SCTP SHOT system before they can attempt to qualify for the Team Championship
2. Teams consist of 5 players and 1 Team Coach
3. Qualifying will be shot on one of the two *Make-A-Break* fields on the Main Trap Line.
4. Qualifying for this event begins on Saturday, July 11th and ends at 4:00 pm on Thursday, July 16th
5. There is no limit to the number of qualifying attempts a team can make
6. To qualify, each team player will shoot one game of *Make-A-Break*
 - a) Two team players will each shoot one game, followed by another 2 team players, followed by the remaining 1 team player
 - b) The 5 individual scores will be combined, and 325 points is a perfect team score
 - c) If there are tied scores, a shoot-off will be done using pairs of targets at the referee's discretion to determine the top 8 teams
 - d) Team Coaches are encouraged to be on the stage to provide advice to their team players while they are shooting
7. The top 4 teams from each qualification field will be in the Championship Final, and a team can only hold one place in the Final
8. The Team Coach is responsible for getting the players on and off the stage and into the correct shooting position for each game



**Proud Blue Diamond Sponsor of the
Scholastic Shooting Sports Foundation.**



**Ruger is happy to support the SSSF and
its youth development programs.
SASP and SCTP are teaching life skills
through the safe, responsible handling
of firearms.**

SHELLS, RELOADING
SUPPLIES, & SHOOTING
ACCESSORIES!

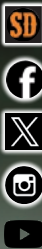

SPORTSMAN'S DEN

SPORTSMANSDEN.COM
INFO@SPORTSMANSDEN.COM

ONLINE
24/7

MON, WED, FRI 9-8;
TUE, THURS, SAT 9-5;
CLOSED SUNDAYS

STORE
HOURS

201 N. GAMBLE ST.,
SHELBY, OHIO 44875
419.347.3007

VISIT
OR CALL

DEN GEAR ~ NOW IN STOCK!



**WE'RE LOCATED IN
BUILDING A - UNIT 12**

WE STRIVE TO HAVE THE AMMO & RELOADING ITEMS YOU
NEED AT THE SHOOT - EVEN IF SUPPLIES ARE LIMITED!



12GA



2 3/4 OR 3 DR ■ 7.5 OR 8



Remington

ASSORTED LOADS!

SPECIAL SHOOT PRICES ON GUNS!



SPORTSMAN'S DEN EXCLUSIVE!



BT-99 AR

\$100⁰⁰ OFF

12GA., 32" and 34" w/Adjustable Rib



SASP ACTION SHOOTING SCHEDULE OF EVENTS

Friday, July 10 - Presented by Walker's

- 8:00am - 5:00pm Check-In and Registration - Pistol Building (Red Feather Outfitters) near range 2 bays
- 8:00am - 6:00pm Practice Bays available
- 9:00am Morning Schedule Slots Begin
- 1:00pm Afternoon Schedule Slots Begin

Saturday, July 11 - Presented by Tippman Arms and Next Level Training

- 8:00am - 5:00pm Check-In and Registration - Pistol Building (Red Feather Outfitters) near range 2 bays
- 8:00am - 6:00pm Practice Bays available
- 9:00am Morning Schedule Slots Begin
- 1:00pm Afternoon Schedule Slots Begin

Sunday, July 12 - Presented by Federal Ammunition, Remington Ammunition, and CCI

- 8:00am - 5:00pm Check-In and Registration - Pistol Building (Red Feather Outfitters) near range 2 bays
- 8:00am - 6:00pm Practice Bays available
- 9:00am Morning Schedule Slots Begin
- 1:00pm Afternoon Schedule Slots Begin

Monday, July 13 - Presented by TANDEM KROSS & Taurus

- 8:00am - 5:00pm Check-In and Registration - Pistol Building (Red Feather Outfitters) near range 2 bays
- 8:00am - 6:00pm Practice Bays available
- 9:00am Morning Schedule Slots Begin
- 10:00am Team GLOCK Demo - Range 1
- 12:00pm Glock Beat the Pro Competition
- 1:00pm Afternoon Schedule Slots Begin
- 3:00pm Team GLOCK Demo - Range 1
- 4:00p - 5:30p Try the new Tankdemkross TKX22 on Range 1

Tuesday, July 14 - Presented by GLOCK

- 8:00am - 5:00pm Check-In and Registration - Pistol Building (Red Feather Outfitters) near range 2 bays
- 8:00am - 6:00pm Practice Bays available
- 9:00am Morning Schedule Slots Begin
- 10:00am Team GLOCK Demo - Range 1
- 1:00pm Afternoon Schedule Slots Begin
- 4:00p - 5:30p Try the new Tankdemkross TKX22 on Range 1

Wednesday, July 15 - Presented by MidwayUSA Foundation

- 8:00am - 5:00pm Check-In and Registration - Pistol Building (Red Feather Outfitters) near range 2 bays
- 8:00am - 6:00pm Practice Bays available
- 9:00am Morning Schedule Slots Begin
- 1:00pm Afternoon Schedule Slots Begin
- 3:30p - 5:00p Try the new Tankdemkross TKX22 on Range 1
- 5:00pm **All Industry Opening Ceremonies, States/Teams Parade - Grandstands | Line up for parade starts at 4:30p**

Thursday, July 16 - Presented by Beretta

- 8:00am - 5:00pm Check-In and Registration - Pistol Building (Red Feather Outfitters) near range 2 bays
- 8:00am - 6:00pm Practice Bays available
- 9:00am Morning Schedule Slots Begin
- 1:00pm Afternoon Schedule Slots Begin
- 5:30pm Pizza Party at CEB Pavilion

SASP ACTION SHOOTING SCHEDULE OF EVENTS

Friday, July 17 - Presented by Winchester

| | |
|-----------------|---|
| 8:00am - 5:00pm | Check-In and Registration - Pistol Building (Red Feather Outfitters) near range 2 bays |
| 8:00am - 6:00pm | Practice Bays available |
| 9:00am | Morning Schedule Slots Begin |
| 9:00am - 4:00pm | Tippmann Arms Side Match |
| 10:00am | Team RUGER Demo - Range 1 |
| 12:00pm | Ruger Beat the Pro Competition |
| 1:00pm | Bucket Raffle drawn after Safety Brief in the Pistol Building, Afternoon Schedule Slots Begin |
| 3:00pm | Team RUGER Demo - Range 1 |
| ~7:00pm | Rifle & Revolver Awards - Banquet Hall, National Raffle Tickets Drawn |

Saturday, July 18 - Presented by RUGER

| | |
|-----------------|--|
| 8:00am - 5:00pm | Check-In and Registration - Pistol Building (Red Feather Outfitters) near range 2 bays |
| 8:00am - 9:00am | Practice Bays available |
| 9:00am | Morning Schedule Slots Begin |
| 11:00am | All Bucket raffle items must be claimed |
| ~7:00pm | Pistol Awards - Banquet Hall |



Shoot with Team GLOCK

By the age of 15, Morgan Leonhardt had become the youngest USPSA National Champion and IPSC World Champion. Visit her demo on Monday the 13th and Tuesday the 14th for the chance to compete against her at SASP stages!



Shoot with Team RUGER

Friday, July 18th with sponsored athletes Connor Knapp and Kaleb Klein. Both are SASP Collegiate Athletes!



TIPPMANN ARMS

Tippmann Arms Side Match with winner for the fastest time receiving a Tippmann Arms rifle! Match runs Friday, July 18th 9am - 4pm.



Athletes are invited to come and try the new TKX22 Light Rifle by Tandemkross on Range 1 from 4:00p - 5:30p on Monday (13th) & Tuesday (14th) and again from 3:30p - 5:00p on Wednesday (15th).

RAFFLE TICKETS

SASP National Gun Raffle tickets will be for sale at the SASP Registration. All bucket raffle items must be claimed by 11:00am on July 18th.

PRACTICE BAYS

Practice bays will be available during the week for teams to practice their skills prior to competing in the SASP match. Hours are: 8:00am to 6:00pm (8-9am on July 18th). Teams will need to schedule time on the practice bays. Availability is in 15-minute increments. Price is \$10 a team for 15 minutes. *Coach supervision is required to purchase and schedule time on the practice bays and while the team practices.

SASP NATIONALS AWARDS

Main Event Awards

Pistol Centerfire Iron & Optic, Rimfire Iron & Optic, Centerfire Revolver, Rimfire Revolver, 1911 and Ultimate: 1st – 3rd Each Division | Intermediate & Senior

Rifle Rimfire Iron & Optic, and Pistol Caliber Carbine
1st-3rd Each Division | Rookie, Intermediate & Senior

SASP WALKER’S HOA AWARDS

Main Event Awards

Pistol

High Overall Male & Female: 1st – 3rd
Intermediate Entry
Intermediate Advanced
Senior – Junior Varsity
Senior – Varsity

Rifle

High Overall Male & Female: 1st – 3rd
Rookie
Intermediate Entry
Intermediate Advanced
Senior – Junior Varsity
Senior – Varsity

SUMMER BLAST

Awards for collegiate athletes competing alongside their high school team

MATCH INFORMATION & GUIDELINES

Age Divisions

Rookie Division (Rifle Only): 5th Grade and under

Intermediate - Entry: 6th to 8th Grade (First year competing as Intermediate)

Intermediate - Advanced: 6th to 8th Grade (Second year competing as Intermediate)

Senior - Junior Varsity: 9th to 12th Grade (First year competing as a Senior)

Senior - Varsity: 9th to 12th Grade (Second & subsequent years competing as a Senior)

**Eligibility ends with graduation from highschool or once a student reaches his/her 20th birthday, whichever comes first.

Pistol

| Rimfire Division | Centerfire Division | Centerfire Revolver | Rimfire Revolver | 1911 Division |
|------------------|---------------------|---------------------|------------------|---------------|
| Iron Sight | Iron Sight | Iron Sight | Iron Sight | Iron Sight |
| Optic Sight | Optic Sight | | | |
| | Ultimate | | | |

Rifle

Rimfire Division **Pistol Caliber Carbine**

Iron Sights
Optic Sights

Match Fees

Pistol - \$65 per athlete entry | Rifle - \$65 per athlete entry

APPEALS COMMITTEE

Tom Kilbane, Annie Berger, Chris Albertson, Windi Grant, Dan Hurda



The Amateur Trapshooting Association presents the 127th Annual

GRAND AMERICAN

July 29–August 8, 2026

World Shooting & Recreational Complex • Sparta, IL



ULTIMATE SHOOTING
ACCESSORIES



SCAN ME

&
CASTELLANI

PROUD SPONSORS FOR THE
SCTP NATIONAL TEAM

WE SPECIALIZE IN TEAM VESTS
VISIT OUR BOOTH
ASK ABOUT TEAM GLASSES
OR CONTACT US FOR DETAILS



sales@ultimateshootingaccessories.com
(312) 622-2020

www.ULTIMATESHOOTINGACCESSORIES.com

TOP GUN CHALLENGE

Athletes competing in the Top Gun Challenge, Sponsored by Federal, will shoot Trap, Skeet, Sporting Clays, Iron Sight Pistol - Rimfire or Centerfire (fastest time), Rifle (fastest time), and 1911 with their scores from each event being compiled to calculate the winners.

1st Prize - Shotgun, Rifle, and a Pistol

2nd Prize - Shotgun

3rd Prize - Pistol

*If 25 or more athletes compete, we will add a 4th prize

*If 35 or more athletes compete, we will add a 5th prize

Please register for the Top Gun Challenge in the pistol building (Red Feather Outfitters) with SASP Staff BEFORE competing in your first scheduled event.



WHAT MAKES THIS MORE THAN GAME IS

CLAY SHOOTERS THESE DAYS





NATIONAL SWEEPSTAKES SERIES 2026

**\$20
PER
ENTRY**

MULTIPLE ENTRIES
ACCEPTED

**EVERY ENTRY IS
A DONATION TO
YOUR SHOOTING
TEAM & WILL BE
MATCHED!**

**WINNER CHOOSES FROM A VARIETY
OF PRIZES OFFERED BY**

REEDS
Family Outdoor Outfitters

**SCAN TO SEE THE
FULL PRIZE BOARD
OR FIND A
MIDWAYUSA
FOUNDATION
PROGRAM MANAGER**



**TO ENTER, FIND A MIDWAYUSA FOUNDATION
REPRESENTATIVE AND MAKE YOUR DONATION
ON-SITE. GRAND PRIZE ENTRIES ONLY OFFERED AT
SELECT EVENTS, WINNER ANNOUNCED IN DECEMBER.**



LOCATED BETWEEN
BUILDINGS 1 AND 2

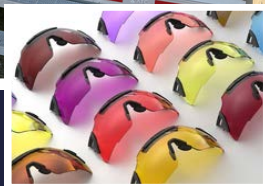
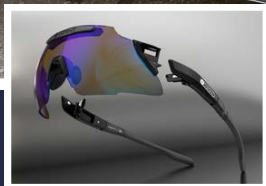
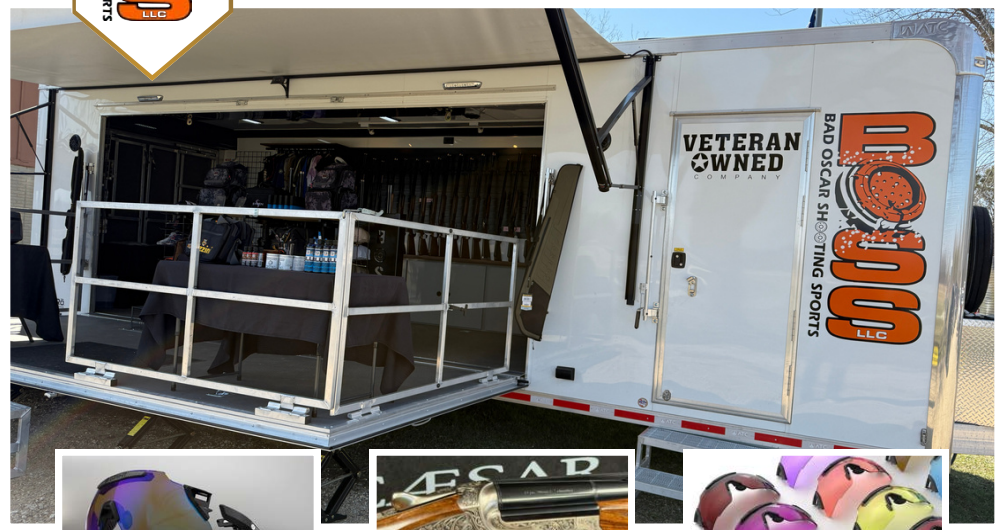

BAD OSCAR SHOOTING SPORTS



We pride ourselves in building strong and lasting relationships with our clients. From selection to fitting, we make sure our clients find the perfect firearm for their needs. Stop by our mobile showroom, and browse our selection of fine firearms & X Sight shooting glasses!

Don't forget to join us for the annual "Pizza Night". Over 600 Pizzas will be served!



DEALERS FOR...

- ✓ Caesar Guerini
- ✓ Blaser
- ✓ Rizzini
- ✓ Fabarm
- ✓ X Sight

And More!

Now Carrying X Sight 3RX Shooting Glasses!

Stop paying over inflated markups. X Sight 3RX Shooting Glasses; quality, clarity and adjustability all at a reasonable price!



CONTACT US NOW!

715-388-8411

Follow Us On
Facebook





SCTP NATIONALS SCHOLARSHIPS

Please register for the Scholarships before competing in your event.



200 Target Trap Event

Browning Scholarship of \$8,500 to the Top Registered Athlete shooting a Browning Shotgun for the 200 Target Trap Event at SCTP Nationals!



200 Target Skeet Event

The top score shot using a Beretta Shotgun will win a Beretta 694 Sporting! Compliments of Beretta and the SCTP!



200 Target Sporting Clays Event

The top score using a Fabarm Shotgun will win a L4S Sporting! Compliments of Fabarm USA!



**SCAN QR
CODE TO
REGISTER**

PERFECTLY BALANCED
QUICK POINTING
LOW RECOILING

PROUDLY MADE IN THE USA
and KOLAR proudly supports the



 **KOLAR**
The Mark of Performance

kolararms.com



RUGER

ARMS MAKERS FOR RESPONSIBLE CITIZENS®

RUGER PROUDLY SUPPORTS THE
SCHOLASTIC SHOOTING SPORTS FOUNDATION

 RUGER.COM



GO WILD

WILDCAT.



**FAST.
FLAWLESS.
FUN.**

WINCHESTERGUNS.COM

WINCHESTER 

REPEATING ARMS

WINCHESTER IS A REGISTERED TRADEMARK OF OLIN CORPORATION.

**AMERICA'S
BEST**

AA®

**TRAP &
SKEET**

**OFFICIAL CLAY TARGET
OF THE
SCHOLASTIC CLAY TARGET PROGRAM**



**PITCH AA TRAP & SKEET
TARGET FEATURES**

- Distinctive AA design - Superior weight and dimensional tolerances provide the most consistent competition target of its era.
- Bright fluorescent paint for visibility in all lighting conditions, 8 colors available.
- Vapor Breaks to prevent targets from sticking together when wet.



(135 TARGETS PER CASE)



LEARN MORE ABOUT
WHITE FLYER PRODUCTS
© 2025 Olin Winchester, LLC

WHITE FLYER



**When
WINNING IS
EVERYTHING**

**OFFICIAL AMMUNITION
OF THE
SCHOLASTIC CLAY TARGET PROGRAM**

Winchester® AA® shotshell target loads are used by the most demanding sport shooters throughout the world. Built here in the United States for 61 years, the famous AA load features the best components, hard hitting high Antimony shot, and performance on target that is unmatched.

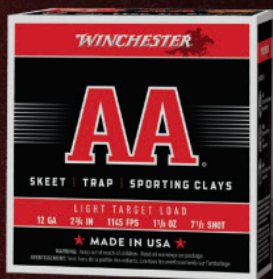

**HARD HITTING HIGH
ANTIMONY SHOT**

+ Premium shot for the most demanding targets and competitions

QUALITY COMPONENTS

- + Legendary AA® Collapsible dual-hinged wad reduces felt recoil
- + Best-in-class powder and primers provide reliability shot after shot
- + High strength hull for consistent reloads



LEARN MORE ABOUT
WINCHESTER PRODUCTS



WHERE CAN I BUY WINCHESTER AMMUNITION?
Visit Winchester.com to find a dealer near you!

© 2026 Olin Winchester, LLC



CHAMPIONSHIPS ARE WON IN GREEN.

MADISON SHARPE

SPORTING CLAYS CHAMPION



BECAUSE SECOND PLACE ISN'T THE GOAL.

Trusted by world champions and target shooters across the world, Premier® Nitro 27® is the ultimate target shotgun shell when it comes to dusting clays. Sporting, trap, or skeet, this shell has a variety of different payloads and shot sizes to match a shooter's preference. Our shell is finished off with our iconic gold unibody hull which withstands multiple reloads and represents the unmistakable Remington.



Remington.com



EYE CATCHING. TARGET SHATTERING.

Designed for clay shooting, the A400 L Sporting features a fast B-Link® gas system, Steelium® Plus barrel, and smooth-cycling controls for low recoil and quick follow-up shots.

A400 L SPORTING



FIND IT AT YOUR LOCAL DEALER

To learn more, scan the QR code or
visit Beretta.com



2026 SCHOLARSHIP RECIPIENTS

SSSF BRUNO BUTTI & MAE (DOMENICA CARERI) BUTTI SCHOLARSHIP FUND - \$3000

Emily Bush
Spencer Clark
Kinsey Duzan

Tanner Gibson
Luke Jannusch
Madison Krummery
James McAllen

Jakob Mosegaard
Quinten Polking
John Schneider

SSSF SCHOLARSHIP FUND - \$500

Xzavier Anderson
Brennan Asmundson
Grace Barton
Dagmar Beckel
Morgan Berg
Bridger Berta
Jake Blodgett
Alivia Boike
Ian Bolton
Abigail Brabham
Moses Brandfess
Cali Jo Brown
Carson Brown
Mary Ida Brown
Mitchell Brown
Sally Brown
Hayley Burke
Kayce Busby
William Ford Carey
Levi Chambers
Mark Chernolutskiy
Jayce Clutter
Carson Courchaine
Kyle Czaplewski
Brayden Dach
Cheyenne Davidson
Justin Deleo
John Duld

Emmalyn Early
Blake Eichhorn
Evelynn Erhardt
Derek Ewald
Preston Feuerbach
Clare Finney
Cora Frangipane
Briley Galgan
Blake Genske
Edmund Gerrick
Allison "Trace" Green
William Gullatt
Matthew Guzzardo
Natalee Haack
Thomas Wayne Hastings
Casey Haugen
Christopher Hill
Chelsi Holden
Benjamin Horne
Jillian Hudson
Chase Humpal
Madison Hunter
Anneliese Huss
Tristan Isbell
Savannah Joerndt
Charlie Jones
Nicholas Kelchen

Kaden Kloster
Ross Kohler
Johannah Kraus
Hunter Kruse
Lane Kruse
Jonathan Lackey
Reyana Ladd
Brayden Laflamme
Cody Lang
Jackson Larson
Vishwa Lavu
Samantha Lee
Tatem Leuschen
Jolene Line
Hayden Lipsey
Xachary Long
Caden Lucia
Grant Lytle
Roman Madvig
Hunter Magnus
Kelly Maier
Parker Maier
Olivia Marsden
Reed Thomas McCown
Willis McCranie
Morgan McMurchy
Lauren Meacham
Nolan Meachum



2026 SCHOLARSHIP RECIPIENTS

SSSF SCHOLARSHIP FUND - \$500

| | | |
|----------------------|----------------------|-----------------------|
| Cael Mess | Brendan Riggins | Joseph Thielen |
| Myra Morgan | Jackson Rivers | Teague Thompson |
| Kyson Moss | Hannah Roark | Peyton Tindle |
| Ann Denny Muehleisen | Richard Schickler IV | Max Trepanier |
| Remington Munson | Madelyn Schnier | Aidan Tucker |
| Kaitlyn Myers | Charlotte Schrum | Kathryn Untch |
| Gauge Nester | Matt Seefeldt | Grace Vining |
| Hank Neufeld | Dylan Shaheen | Andrew Waddington |
| Zachariah Ogren | Calvin Shields | Tabitha Wagner |
| Brayden Ojeda | Benjamin Shirah | Olivia Waldron |
| Reese Parker | Addison Shouse | David Walker |
| Emma Parsisson | Mason Sierien | James Walker |
| Katlyn Parson | Aiden Skindingrude | Maxwell Walstien |
| Luca Paullo | Callie Slayton | Margaret Warner |
| Ridge Pearson | Porter Snyder | Clara Weber |
| Henry Perdue | Nolan Spettel | Reese Wendlandt |
| Grant Perkins | Liberty Starrett | Allie Whelstine |
| Mylie Piekarski | Mia Starrett | Davis Wieberdink |
| M. Alex Pocernich | Ethan Steffens | Austin Wildman |
| Caleb Poisson | Callum Steinke | Tyler Williams |
| Kieran Polking | Dakota Stephens | Brody Wilmoth |
| Boone Pollard | Katelyn Stewart | Ross Wilson |
| Hali Ponce | Trent Stiller | Shane Wilson |
| Zachary Quint | Joseph Lee Stokley | Aidyn Gage Yarborough |
| Morgan Ray | Sejal Sundaram | Morgan Yost |
| Brianna Raymond | Lily Syfert | Sydnee Young |
| Maddison Reifsteck | Adaline Taylor | |
| Ethan Ressler | Carson Taylor | |
| | Kory Taylor | |

Since 2013, the SSSF has awarded over \$1,344,500 in scholarship funds benefiting over 1,450 student athletes, from nearly all 50 states in the Scholastic Clay Target and Scholastic Action Shooting programs. We are pleased to announce that the SSSF awarded \$120,000 in scholarships in 2026!

IT'S ALREADY IN YOUR BLOOD
DON'T LET IT GET IN YOUR HEAD



Available at Retailers Now

913-362-9455 • hodgdonpowderco.com

INNOVATION. LEADERSHIP. WINCHESTER.



USA READY™
DEFENSE



17 WSM



AA*



Long Beard® XR*



Final Pass™



Deer Season XP*



Expedition Big Game
Long Range

Winchester stands as an iconic American brand with global recognition that is synonymous with excellence, reliability and innovation.

WINCHESTER 
The American Legend™



WHERE CAN I BUY WINCHESTER AMMUNITION?
Visit Winchester.com to find a dealer near you!
© 2026 Olin Winchester, LLC



SYREN

DEMOS AVAILABLE

You wouldn't wear his shoes. So why shoot his gun?

Syren is the first and only brand of firearms designed exclusively for Women. Each Syren shotgun is as elegant and unique as its owner. A perfect fit.

FOR MORE INFO VISIT SYRENU.SA.COM

FROM OUR PRECISION SHOOTING FAMILY TO YOURS

GOOD LUCK AT NATIONALS!



Learn more about our precision products, sponsorships, and junior program at capstonepg.com

825 CITORI



BROWNING.COM

CAMPING

SCTP / SASP NATIONALS

- ALL visitors must register with the office upon arrival. Daily Fee of \$5 fee per adult and \$3 fee per child age 11 and under, which allows visitors swimming and fishing privileges.
- ALL visitors are asked to leave the grounds by 10 p.m. CURFEW is 10 p.m. for ages 17 and under. QUIET time will be observed from 11 p.m. to 8 a.m.
- ONE unit per site for a family of four (2 adults & 2 children). One additional child size tent (5 ft. sq.) is permitted. Additional guests are to pay daily rate. Limit 8 guests per site.
- PLEASE observe the posted speed limit. Watch for children and pets. Violators of this rule may be removed from competition with no refund.
- NO lifeguard on duty, do not leave children unattended.
- RECREATION, pool & shower facilities are for the sole use of paid guests.
- YOU are responsible for your children and those of your visitors. Children age 14 and under must have adult supervision while using the facilities.
- PLEASE do not cut through occupied sites.
- NO state license is required to fish in the stocked lake. Catch and release only.
- WE welcome friendly pets on leashes (do not leave unattended). Please clean up after your pets. Pets are not permitted in cabins, buildings, or pool area.
- NO fireworks of any kind are permitted on our grounds.
- CAMPFIRES in fire rings only. ONE fire ring and picnic table per site. DO NOT remove the fire rings or tables. NO portable grills on picnic tables.
- NO dumping of gray water on any part of the grounds.
- GOLF CARTS must be driven by licensed drivers only, with proof of insurance; and may only be driven on roads and golf cart paths.
- NO ATVs, mini-bikes, motorized scooters, or dirt bikes may be used to drive about the grounds. NO bicycles after dusk.
- ONLY 2 vehicles per site. Utility trailers, boats and extra vehicles may be parked in storage area for \$35 per month.
- NO mail delivery on the grounds – please rent a P.O. Box in Marengo. Also no personal messages delivered to sites.
- PLEASE keep park clean; place trash in dumpsters or receptacles. Cutting of trees or shrubbery is prohibited.
- NO outside refrigerators, washers, or dryers permitted.
- WASHING of campers/RVs is not permitted (please use Sparkle 'n Shine Car Wash, featuring an outdoor RV bay).
- NO alcohol permitted in recreational buildings, in the pool, or on golf carts. Drunken or rowdy behavior will not be tolerated.
- UNRULY guests will be asked to leave the premises.

We reserve the right to discharge any persons, without refund, for failure to abide by any of the campground rules or guidelines. Please notify SCTP or SASP Registration or SSSF Staff, of any inappropriate behavior.



WE'RE PROUD TO

SUPPORT THE SPORT

Level Five Solutions provides **website** and **app design** and **digital strategy**. Learn more about what we do, including our work with SSSF/SCTP, at <https://levelfivesolutions.com/firearms/>

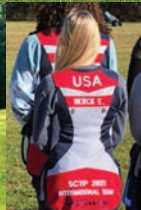



**TIPPMANN
ARMS**

RCR 26



- Competition Ready
- .22LR Semi-Auto
- 16" Magna-Lite Barrel
- 3.8 lbs

.22LR

SPEED LOADER

COMPATIBLE WITH:

- Tippmann Arms M4-22 Magazines
- M&P® 15-22 Magazines
- Black Dog X-Form Magazines
- Rock River Arms .22LR Magazines
- Black Dog V208 Magazines
- Gen 1 CMMG Magazines



Tippmann Arms

2955 South Maplecrest Rd
Fort Wayne, IN 46803

☎ 260 245 6155

✉ info@tippmannarms.com

TippmannArms.com



BUILT TO LAST. SIZED TO CARRY.

THE ALL-NEW
58

AMBIDEXTROUS
MANUAL SAFETY
& DECOCKER

DRIFT
ADJUSTABLE
REAR SIGHT

.380 ACP
15-ROUND
CAPACITY

DA/SA
TRIGGER

INTEGRATED
FRONT SIGHT

ALUMINUM FRAME
WITH ALLOY STEEL OR
STAINLESS STEEL SLIDE

 **TAURUS**
TaurusUSA.com

AMMUNITION

Ammunition will be available at Sportsman's Den and SCTP/SASP registration areas. All athletes are responsible for their own ammunition.

GOLF CART AND UTV RULES

- All personal UTV's and golf carts must registered at the camp ground office.
- GOLF CARTS and UTVs/SIDE BY SIDES must be driven by licensed drivers only, with proof of insurance; and may only be driven on roads and golf cart paths.
- NO ATVs, mini-bikes, motorized scooters, or dirt bikes may be used to drive about the grounds. NO bicycles after dusk.
- Posted speed limits must be observed.

For complete campground and facility rules, go to:
<http://bit.ly/1X6SFO9> (or scan QR code).



GOLF CART RENTALS

All of the golf car rentals at Cardinal Center are handled by Eagle Golf Cars. If you are interested in renting a golf car, contact them at:

888-432-3059 | eaglegolfcars@aol.com | eaglegolfcars.net

DIRECTIONS

Cardinal Shooting Center | 616 State Rt. 61 | Marengo, OH 43334

From Columbus: Take I-71N 29 miles to exit 140 toward Mt. Gilead/Galion. Exit I-71, then take a left on OH-61 north. Go 0.5 miles on OH-61 and enter the facility on the left via Cardinal Drive.

From Cleveland: Take I-71S for 110 miles to exit 140 toward Sunbury/Mt. Gilead. After exiting I-71 take a right on OH-61 north. Go 0.5 mile on OH-61 and enter the facility on the left via Cardinal Drive.



ALL

TRAVIS MEARS

National Sporting Clays Champion



FIOCCHI WHITE RINO™

Collegiate and serious trap shooters choose Fiocchi shotshells for a reason. Our superior components, derived from innovation, Old World craftsmanship, and our 140-year heritage, produces the most accurate and reliable ammunition on the market today.

FIOCCHI.
FIOCCHIUSA.COM

FEDERAL

VINCENT HANCOCK

Team Federal Shooter

- 20+ World Cup Medals
- 5-Time Olympic Medalist
- 4-Time World Champion
- 3-Time Pan American Games Champion

FOUR GOLDS | ONE EVENT

ONE HE TRUSTS



GOLD MEDAL® PAPER | HIGH OVER ALL™ | MASTER CLASS™

Vincent Hancock is One of One when it comes to International Skeet Shooting. He's one of only four Americans and six in the world to win four Olympic gold medals in one event. When it comes to shotshells, there's only one brand he trusts—Federal®. From the world stage to the main event, Skeet to Sporting Clays, Hancock chooses from Federal's lineup of championship products.



**WE'RE PROUD TO
SUPPORT THE SCHOLASTIC
CLAY TARGET PROGRAM,
AS PART OF OUR
COMMITMENT TO THE FUTURE
OF SHOOTING SPORTS.**

**Mossberg— Makers of
dependable, hardworking firearms
for more than a century.**

SAFETY TIP 
Store firearms securely, inaccessible
to children and unauthorized users.

MOSSBERG[®]
SINCE 1919

ADDITIONAL GUIDELINES FOR SCTP & SASP

1. Current ATA, NSCA, NSSA, USA Shooting and SASP rules, as well as rules in this program and any match or National Director's bulletins posted on this range, govern this match.
2. All participating athletes and coaches must be registered and fully paid with the SSSF before competing. Event registrations are accepted on a first-come, first-served basis. For SCTP and SASP, all reservations will be done electronically through the team login at www.sssfonline.org.
3. All ammunition and practice rounds are the responsibility of the participant.
4. Alcohol/illegal or individually non-prescribed drugs and firearms do not mix. Alcohol and other illegal substances are strictly forbidden by the SSSF during this event. Further, any person who is found to be in possession of, or under the influence of, alcohol or drugs while using, cleaning, maintaining, inspecting, or otherwise handling their shotgun or any other firearm at any time will be immediately disqualified from the entire event and asked to leave without refund.
5. Safe gun handling and appropriate shooting attire are required. Flip-flops and open-toed/ heeled shoes are prohibited. **Tops:** Shirt must have sleeves. Items of clothing that expose any part of the torso are prohibited. These include, but are not limited to, cutoff T-shirts, halter tops, tank tops, etc. **Bottoms:** Short shorts and low riding shorts or pants revealing undergarments or buttocks are prohibited.
6. **Hat Shooting is strictly prohibited during this event.** Any Competitor or coach who participates in hat shooting will be immediately disqualified and asked to leave the competition without refund.
7. All athletes must sign the score sheet (next to the score total) before leaving the range.
8. Use of any tobacco product by anyone under the age of 18 is against Ohio State Law, and any use of tobacco product by an SCTP/SASP participant is against SSSF guidelines. Participating in the use of tobacco products can be grounds for disqualification from the tournament.
9. Any athlete or adult disqualified from the tournament will not receive a refund of any tournament fees, game fees, practice fees or any other funds paid to SSSF or its agents.
10. SASP ties will be broken per rule book. If a tie occurs for final ranking, the In & Out stage score will be used as the tie-breaker. If that does not break the tie, the fastest single run of that stage will be used as the tie-breaker. If still needed, the second and third run will be used as the tie breaker.

****COACHES: You are expected to uphold and enforce this dress, conduct and safety code! The athlete may be given one (1) warning, and subsequent violations will result in disqualification from the event.****



WORLD'S BEST TRAPS

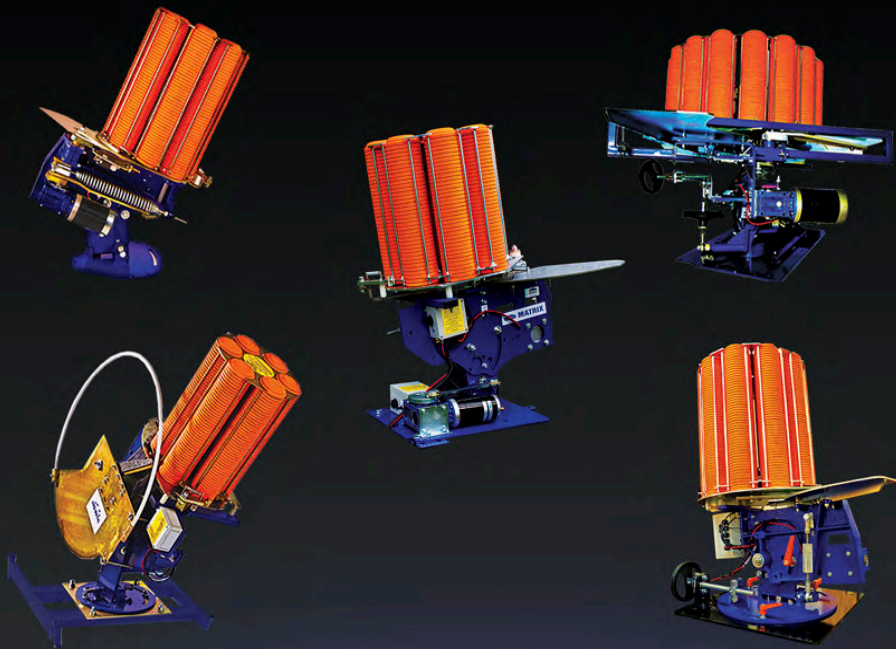

PROUD TO SPONSOR THE SCTP

SKEET | TRAP | SPORTING | OLYMPIC

**888.767.2529 | WWW.PROMATIC.BIZ
FOR THE DEALER NEAREST YOU**

ACUI and SCTP are Proud to Partner for Their 2026–27 Collegiate Shooting Sports Season



SAVE THE DATE:

2027 Collegiate Clay Target National Championships
March 14-20, 2027; San Antonio, TX

2027 Collegiate International National Championships
July 6-9, 2027; Marengo, OH

Find the full schedule & our Team Directory at: www.acuiclays.org

If you would like to learn more about the ACUI and SCTP collegiate program, please contact Taylor Blechschmid at tblechschmid@acui.org or Wayne Rasmussen at wayne@mysctp.com

 **ACUI**
Clay Targets IN PARTNERSHIP
WITH



Next season's dates:**2026 Collegiate International National Championships**

Cardinal Shooting Center
(Marengo, OH)
July 7-10

2026 Upper Midwest Conference Championships

Cardinal Shooting Center
(Marengo, OH)
October 2-4

2026 Fall Central Midwest Conference Championships

World Shooting Complex
(Sparta, IL)
October 9-11

2026 Greater Midwest Super Shoot

Heartland Public Shooting Park
(Grand Island, NE)
October 15-18

2026 Upper East Coast Conference Championships

Prince George County's Trap and Skeet Center
(Glenn Dale, MD)
October 30 – November 1

2026 Fall Lower East Coast Conference Championships

Jacksonville Clay Target Sports
(Jacksonville, FL)
November 6-8

2026 Fall West Coast Conference Championships

Pikes Peak Gun Club
(Colorado Springs, CO)
November 13-15

2027 Spring West Coast Conference Championships

Clark County Shooting Complex
(Las Vegas, NV)
January 15-17

2027 Lower Midwest Conference Championships

National Shooting Complex
(San Antonio, TX)
January 29-31

2027 Spring Lower East Coast Conference Championships

Forest City Gun Club
(Savannah, GA)
February 5-7

2027 Spring Central Midwest Conference Championships

Location TBD
Dates TBD

2027 Collegiate Clay Target Championships

Nationals Shooting Complex
(San Antonio, TX)
March 14-20

2027 Collegiate International National Championships

Cardinal Shooting Center
(Marengo, OH)
July 6-9



2026 SCTP PROGRAM SPONSORS

BENEFACTOR



CHANGING THE FUTURE OF
YOUTH SHOOTING SPORTS

FOUNDING SPONSOR



RED DIAMOND SPONSORS \$100K PLUS ANNUALLY



WINCHESTER
AMMUNITION

BLUE DIAMOND SPONSORS \$75K PLUS ANNUALLY



BLACK OPAL SPONSORS \$50K PLUS ANNUALLY



TITANIUM SPONSORS \$35K PLUS ANNUALLY



PLATINUM SPONSORS \$20K PLUS ANNUALLY



GOLD SPONSORS \$15K PLUS ANNUALLY



SILVER SPONSORS \$10K PLUS ANNUALLY



BRONZE SPONSORS \$5,000 PLUS ANNUALLY

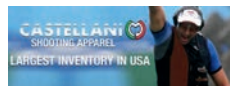

USA ULTIMATE SHOOTING ACCESSORIES

COPPER SPONSORS \$2,500 PLUS ANNUALLY



BRASS SPONSORS \$1,000 PLUS ANNUALLY



SUPPORTERS \$500 PLUS ANNUALLY



PARTNERS





POSSESS THE ADVANTAGE
Ultimate Performance & Reliability

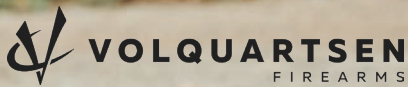

The Great outdoors Company, Inc.



BUILDINGS B-11 & B-12



SCTP/SASP GIFT SHOP
NATIONALS T-SHIRTS
CARDINAL GIFT SHOP



*Cardinal Center Logo Merchandise

- CROCS
- UNDERARMOUR
- SHOOTING GIFTS
- DRAKE SHOOTING SHIRTS
- LONESOME CHARLIE LEATHER GOODS



**BRINGING PEOPLE TOGETHER
THROUGH SPORT AND SPIRIT**

**Negrini is Proud to Support The
Scholastic Clay Target Program**

How It Works:

When you purchase a Negrini shotgun case featuring the official SCTP logo, a contribution of the sale is donated directly to fund youth participation in trap, skeet, and sporting clays, and you will automatically save 20% off the retail price of selected cases.

Learn more: negrinicasestore.com/sctp-negrini
Personal fitting consultation: 833-634-7464
Distributed by International Case Company



**TRAIN
AT
HOME
WITH
AIRSOFT**



mOS
MANUFACTURE



TARGET STANDS

**Practice on the targets
used at the SASP World**

**Record National
Championships**

SASP 4 STAGES, COMPLETE SET

Includes: FOCUS, GO FAST, IN & OUT, SPEED TRAP

- 4- 10" circles*
- 11- 12" circles
- 5- 18x24 rectangles
- 20- mounting caps
- 20- HD Bases
- 4- aiming point flags

STEEL TARGET PAINT, 6 CANS WHITE

Retail: **\$3,990.00**

Team Price: **\$3,445.00**



Visit us at the Rhino Rig!



ELITE

CHOKES

- Barrel Porting
- Gunsmithing
- Competition Chokes
- Outdoor Series Chokes
- **ELITE SERIES CHOKES**

 **RHINOCHOKES.COM**

 **800.226.3613**





2026 SASP PROGRAM SPONSORS

BENEFACTOR



CHANGING THE FUTURE OF
YOUTH SHOOTING SPORTS

FOUNDING & SUSTAINING SPONSORS \$25K + 3YR COMMITMENT



RED DIAMOND SPONSORS \$100K PLUS ANNUALLY



BLUE DIAMOND SPONSORS \$75K PLUS ANNUALLY



PLATINUM SPONSORS \$20K PLUS ANNUALLY



GOLD SPONSORS \$15K PLUS ANNUALLY



2026 SCTP & SASP TEAM CHAMPIONSHIPS

SILVER SPONSORS \$10K PLUS ANNUALLY



BRONZE SPONSORS \$5,000 PLUS ANNUALLY



COPPER SPONSORS \$2,500 PLUS ANNUALLY



BRASS SPONSORS \$1,000 PLUS ANNUALLY



SUPPORTERS \$500 PLUS ANNUALLY



PARTNERS





2026 SASP NATIONAL CHAMPIONSHIP

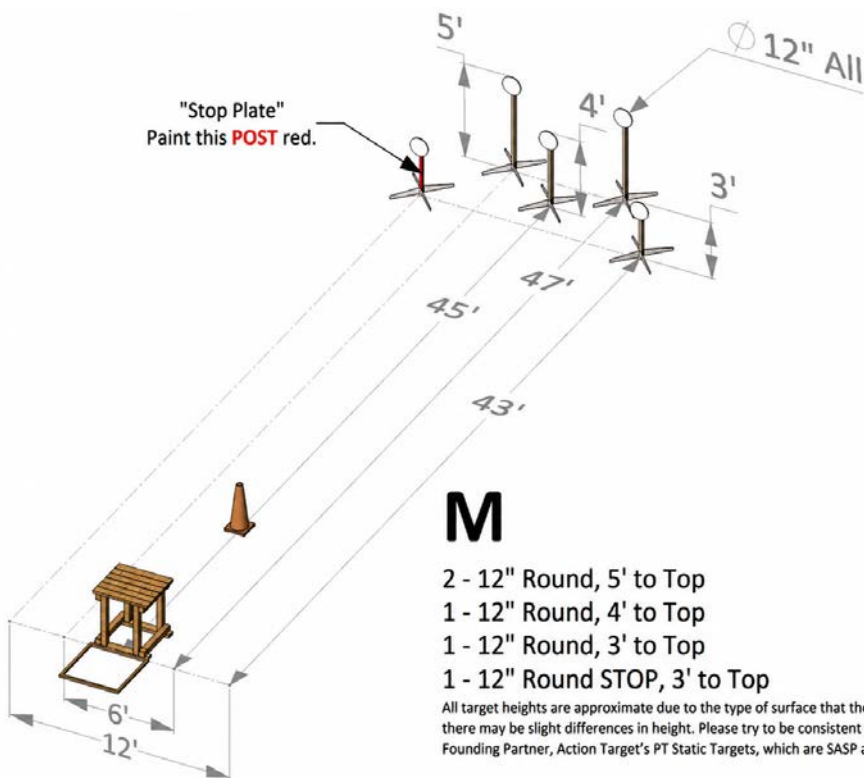

SPONSORED BY:



DONATE TO YOUTH SHOOTING SPORTS TEAMS EVERYWHERE WITH THE SSSF.



**READY TO GIVE A GIFT?
LET'S GET STARTED!**

SSSFONLINE.ORG/DONATE



SSSF
SCHOLASTIC
SHOOTING SPORTS
FOUNDATION

IRA - STOCKS - MUTUAL FUNDS - DONOR ADVISED FUND



ALPEN[®]

OPTICS



0°-50° active

Shop Now

INNOVATIVE SMARTDOT-TECHNOLOGY

MADE IN GERMANY

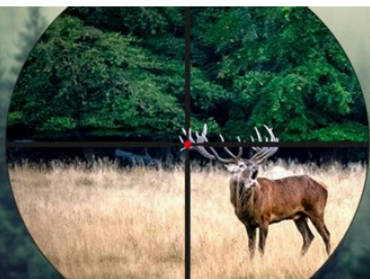

DISCOVER THE DIFFERENCE



WWW.ALPENOPTICS.COM

1010 South 48th Street
Springdale, Arkansas 72762

Phone: 866.252.3811

SSSF will again be having a raffle to support our Foundation's Forever Fund. SSSF has an endowment with MidwayUSA Foundation. If we can grow that account to \$40 million, SSSF would become self-funded through the endowment, ensuring the future of youth shooting sports forever. The Forever Fund Raffle drawing will be held February 19, 2027. Tickets will sell for \$10.00 each and selling teams keep \$5.00 for each ticket they sell. Tickets will be for sale and will also be available for teams to pick up to sell. Please stop by the SASP or SCTP registration buildings to get yours. It is a fantastic way to raise money for your team!



SUPPORT THE SSSF FOREVER FUND ENSURE THE FUTURE OF YOUTH SHOOTING SPORTS



Hornady
Mobilis 12-gun safe
Includes shipping to continental US,
excluding AK & HI
approx. value \$2769
(1 winner)



Winchester Safes
Bandit 19
Includes shipping to continental US,
excluding AK & HI
approx. value \$1319
(1 winner)



Silencer Central certificate for
Banish 30-V2 Suppressor
approx. value \$999
(1 winner)



FUSE

SIG Sauer certificate for
P365 Fuse Optic Ready
approx. value \$819
(1 winner)



Promatic Pigeon
with trolley & foot switch
approx. value \$765
(1 winner)



Taurus Stainless Judge
approx. value \$665
(1 winner)



Certificate for GLOCK
of your choice
approx. value \$600
(1 winner)



RuffLand Performance Kennels
Ultimate Pet Travel System
(Large Kennel/Water Hole/Chow Box)
approx. value \$560
(1 winner)



Ruger certificate for
RXM 9mm
approx. value \$539
(1 winner)



Silencer Central certificate for
SoLo 22 Suppressor
approx. value \$345
(2 winners)



Mantis TitanX
Smart Laser Training Pistol
approx. value \$199
(1 winner)

Drawing will be held on Friday, February 19, 2027. Winners do not need to be present to win. Winners will be posted on SSSF website. Winners will be contacted by phone or email. Prizes will be shipped. Winners not able to lawfully receive their prize in their state will receive \$200.00 in lieu of the prize. No other trades or cash value alternatives. Prizes not claimed within 60 days of drawing are forfeited.

SSSF, 5931 Rofit Rd, San Antonio, TX 78253



2026 SASP NATIONAL CHAMPIONSHIP

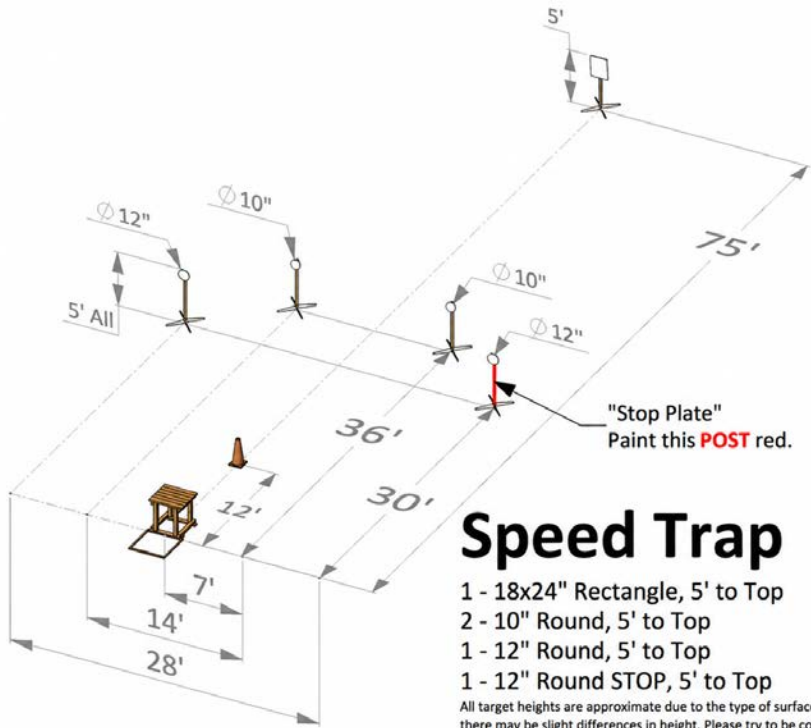

Speed Trap

- 1 - 18x24" Rectangle, 5' to Top
- 2 - 10" Round, 5' to Top
- 1 - 12" Round, 5' to Top
- 1 - 12" Round STOP, 5' to Top

All target heights are approximate due to the type of surface that they are set on; there may be slight differences in height. Please try to be consistent or use our Founding Partner, Action Target's PT Static Targets, which are SASP approved for all stages.

SPONSORED BY:





P211 ***GTO***

SPEED.
MASTERED.

SIGSAUER[®]



NEW BERETTA B22 JAGUAR PISTOL

**Come try out the new pistol on
Range 1 (concrete bays) all week!!**

Over the past four years, SASP staff, coaches, and State Advisors have worked closely with Sustaining Partner Beretta, the world's oldest firearms manufacturer, to help develop and refine a new competition rimfire pistol.

Recognizing the value of competition-driven innovation, SASP also brought Silver Level Sponsor TANDEM KROSS into the project. Together, Beretta and TANDEM KROSS combined their expertise with feedback from SASP to create a firearm designed specifically for the demands of competitive shooting.



**The Beretta B22
Jaguar Pistol will be
available
in stores starting
August 2026**



TRY OUR
OPTICS FINDER

OPTICS FINDER

WHICH OPTIC IS BEST FOR YOU?

Optics Finder is a simple tool that delivers powerful results by turning your answers to a few questions into recommendations for your next optic. Now, our full lineup of hunting and shooting optics is at your fingertips, with the right one just a few clicks away. Visit our website at <https://opticsfinder.vortexoptics.com/preprod/categories>



VIP WARRANTY

IT'S ABOUT YOU, NOT US

VIP stands for a Very Important Promise to YOU, our customer. We will repair or replace your Vortex product in the event it becomes damaged or defective—at no charge to you.



2026 SASP NATIONAL CHAMPIONSHIP

Go Fast!

4 - 18x24" Rectangles, 5' to Top

1 - 12" Round STOP, 5' to Top

All target heights are approximate due to the type of surface that they are set on; there may be slight differences in height. Please try to be consistent or use our Founding Partner, Action Target's PT Static Targets, which are SASP approved for all stages.

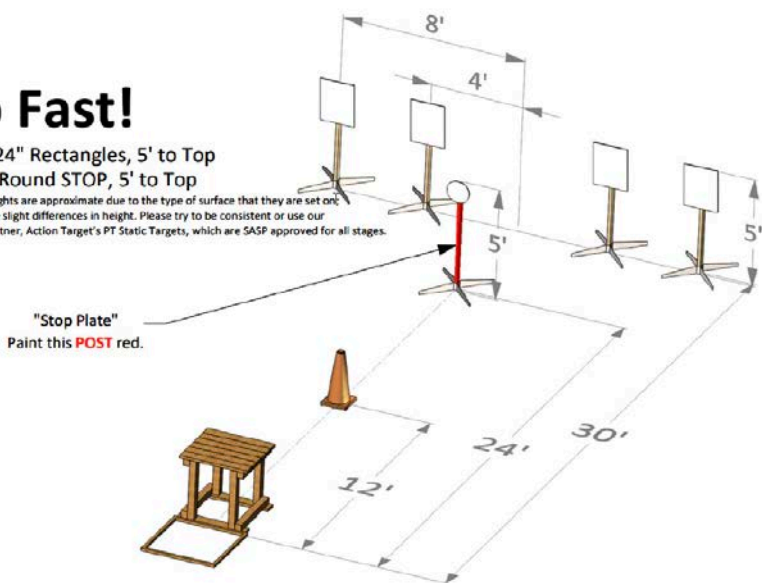

"Stop Plate"
Paint this **POST** red.

SPONSORED BY:



BIRCHWOOD CASEY



PROTECT & MAINTAIN

CLAY TARGET
THROWERS

FIREARM
MAINTENANCE

SHOOTING
ACCESSORIES

METAL
FINISHING

WOOD
FINISHING

FIREARM
CASES

UNIVERSAL
CLEANING KITS

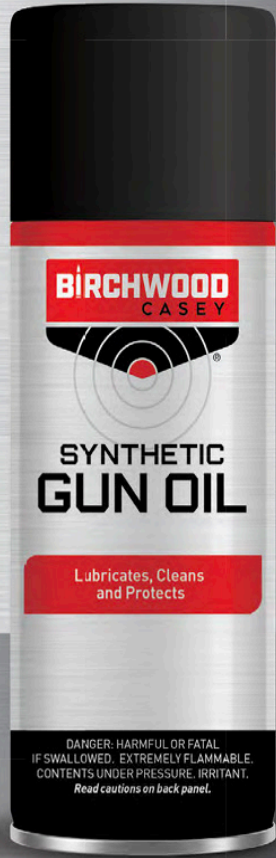
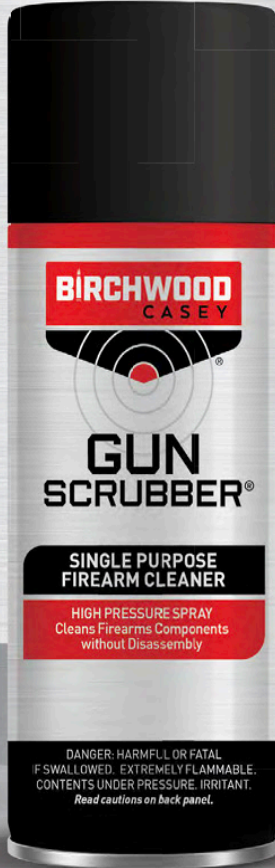

Since 1948, serious shooters, avid collectors and professional gunsmiths have relied on Birchwood Casey for shooting and gun care products that have stood the test of time. From legendary Tru-Oil® Gun Stock Finish and Perma Blue® Liquid Gun Blue to revolutionary Shoot•N•C® Targets, Birchwood Casey has pioneered innovative products with an unwavering dedication for quality.



IMPROVE WITH EVERY SHOT

LIVE FIRE ★ DRY FIRE

THE MANTISX SMART SENSOR AND SMARTPHONE APP CONTINUOUSLY TRACKS THE MOVEMENT OF YOUR FIREARM, ANALYZES BEHAVIOR, GIVES FEEDBACK, AND PROVIDES COACHING TO MAKE EVERY SHOT COUNT.

MANTISX.COM



SHOOT STEEL?



STEEL TARGET PAINT



ONE SHOT COVERS THE SPOT!

RANGESTORE.NET

1.888.488.1114



TACTICAL RANGE BACKPACK

The GPS Tactical Range Backpack is a hands-free, secure solution for transporting pistols, ammo, and accessories.

WWW.GOOUTDOORPRODUCTS.COM



GSR-X-OUT

Waterless Hand Cleaner

GET THE LEAD OUT !

tactical-grit.com

HUNTERS HD GOLD



Brian Conley
Hunters HD Gold



Hunters HD Gold
Command Center Experience

HuntersHDGold.com

Making your Prescription Lenses and Custom Lenses for your frames since 2018.



Rumble.com search Hunters HD Gold



[TK]
TANDEM KROSS

NEW!
TKX22 LIGHT RIFLE

The lightest premium semiauto rimfire rifle in the world is now available!

At three pounds and six ounces unloaded, this top tier plinker is packed to the brim with features you cannot get anywhere else.

The Magpul® MOE® X-22 stock offers space perfect for bipods or ARCA rails while M-LOK® on the barrel begs for sights, lights, optics, and more.

Standard ½"x28 muzzle threads makes this a perfect suppressor host while the adjustable fiber optics sights make it ready for the range right out of the box.

All TKX22 Light Rifles ship with a 3-lb trigger pull with adjustability from 2.5–5.5lbs.

Shipping with a TK DoubleKross Magazine gives you double the rounds with half the hassle. The DoubleKross brings rotary mag reliability while being smaller and lighter than a 15-rounder.

Ready for it? Learn more at
www.TANDEM KROSS.com



CALLING ALL

Athletes, Coaches & Parents

Have you ever wanted to try the International Disciplines? Now is your chance! Join us on the International Trap Fields Monday and Tuesday night to give it a risk free try. For \$5 you will get to shoot 10 targets, play as many times as youd like.

MONDAY 7/13 | TUESDAY 7/14

5:45PM SIGN UP STARTS - LAST SQUAD OUT AT 8PM

**YOUR \$5 ENTRY IS A DONATION TO THE MIDWAYUSA
FOUNDATION ENDOWMENT OF YOUR CHOICE.
ALL TEAM DONATIONS ARE MATCHED!**

FEDERAL 

VICTORY

MADE IN THE USA



FROM AMERICA'S #1 SHOTSHELL BRAND

MASTER CLASS

SUPERIOR PATTERNS ★ HARDER SHOT ★ ONE-PIECE WAD

With a customized **PODIUM™** wad and a swarm of high-antimony lead shot, new Federal® **MASTER CLASS™** is designed to win on the sporting clays and FITASC course.

Break the most challenging targets and teach the competition a lesson.

CONGRATULATIONS TO THE 2026 SSSF ALL-SCHOLASTIC TEAM!

These exceptional student athletes are named to the team in recognition of their excellence in shooting, academics and community involvement.

| | | |
|---------------------|-------------------|----------------------|
| Kyle Adams | Wade Congdon | Savanna Gallagher |
| Martin Addis | Brandt Crerar | Randy Gaytan |
| Westley Alison | Benjamin Cui | Ike Gentry |
| Reid Anderson | Esther Cui | Jack George |
| Kyle Arnold | Rylan Culpepper | Isaac Gledhill |
| Brody Baan | Carmen Cunningham | Grant Glossner |
| Elizabeth Bailey | Sara Daigle | Ava Gomez |
| Ethan Baker | Braden Data | Elijah Gomez |
| Logan Banh | Aidan Davis | Jesse Grant |
| Grace Barton | Ann Davis | Brayden Gray |
| Noelle Basinger | Cruz Davis | Dylan Grieser |
| Brody Batenhorst | Daniel Day | Wyatt Grieser |
| Logan Baumgard | Samuel Deneke | Jacob Griffin |
| Tripp Beisser | Gage Denney | Tyler Grooters |
| Carlin Bennett | Chase Dobrinski | Karter Grossman |
| Zieke Blaine | Ayden Doucette | Maya Grzadzinski |
| Baylee Blakeley | Carly Drake | Austin Hamelink |
| Colt Blumberg | Colton Drallmeier | Jake Hamilton |
| Nash Blythe | Liam Dryden | Brody Hanington |
| Haley Bowen | John Duld | Blake Hankins |
| Ryan Brandon | Hayden Dunn | Caden Harris |
| Elizabeth Breitbach | Daniel Edwards | Hunter Harris |
| Kayden Broderick | Camden Eggert | Daniel Harrison |
| Cali Brown | Holly Elsinger | Ryan Harshbarger |
| Hayley Burke | Karl Engevoid | Trace Hayes |
| Gracie Burton | Evelynn Erhardt | Maddie Hedding |
| Tyler Burton | Nickolas Esposito | Lexi Henning |
| Emily Bush | Tayli Estes | Creston-Murray Henry |
| Grayson Butts | Grady Fallert | Lucas Herda |
| Vincent Calovich | Sophie Fellingner | Madison Herring |
| Benjamin Cameron | Delaney Ferrick | Bennett Hiltbrand |
| Hemi Carlin | Brenden Filler | Kylie Holcombe |
| Zachary Catellier | Allison Fisher | Quin Hollingshead |
| Avery Clover | Ruby Folkestad | Hank Hollingsworth |
| Hamilton Cole | Jonathan Fraiser | Jillian Hudson |
| Reilly Cole | Lawson Frizzell | Tommy Hurda |



| | | |
|--------------------------|------------------|----------------------|
| Andrew Huston | Amelia Long | Amanda Osterman |
| William Hyde | Emily Long | Lillian Ostermeier |
| Spencer Iddings | Aria Maitland | Gabriel Palmer |
| Colton Imburgia | Noah Maldonado | Paitynn Paredes |
| Jacob Issel | Mackenzie Mankey | Ethan Payne |
| Lucas Issel | Clay Marino | Ridge Pearson |
| Carter Jackson | Olivia Marsden | Emma Pendley-Sauceda |
| Luke Jannusch | Carter Marten | Buck Pennel |
| Lily Jennings | Ryan Martin | Theodore Pennel |
| Madeline Johanningsmeier | BaylorRose Mason | Jack Petrosky |
| Ashton Johnsey | Lauren McCown | Avery Petty |
| Hadassah Johnson | Reed McCown | Hailey Phillips |
| Jacob Johnson | Colton McKinney | Nathan Piper |
| Thomas Johnson | Payne McKinnney | Joshua "Wyatt" Poole |
| Cole Johnston | Gage McMinn | Brooks Potter |
| Charlie Jones | Jack McNitt | Logan Price |
| Ivy Kate Jones | Macey McNitt | Matthew Raff |
| Tyler Jones | Haynes McSwain | Lilly Kent Rainey |
| Stella Jordan | Elijah Miller | Will Rainey |
| Colten Kammerer | Alex Mills | Levi Ralston |
| Jenna Keacher | Jakob Moesgaard | Benjamin Randall |
| Sarah Keacher | Cole Montfort | Trevor Randolph |
| Brooklyn Kerkman | Hadley Moore | River Rasmussen |
| Ella Kraus | Eli Morris | Levi Reed |
| Noah Kyle | Wyatt Morrissey | Tanner Reed |
| Jameson Lackey | Finley Moseley | Olivia Rice |
| Jonathan Lackey | Darcey Mosseley | Sophia Rice |
| Jahdek Laforge | Denny Muehleisen | Brendan Riggins |
| Cody Lang | Kaitlyn Myers | Jenna Riley |
| Liam Lawson | Bryce Myrick | Nickolas Rios |
| Mack Lawther | Brayden Ojeda | Brock Roark |
| Shelby Lawther | Camry Olson | Trent Robers |
| Trevor LeBas | Lucas Opitz | Ford Rocker |
| Ethan Liebana | Avery Osborne | Kash Rogers |
| Hayden Lipsey | Dennis Osborne | Benjamin Rook |
| | Erika Osterman | |

CONGRATULATIONS TO THE 2026 SSSF ALL-SCHOLASTIC TEAM!

These exceptional student athletes are named to the team in recognition of their excellence in shooting, academics and community involvement.

Paisley Rosas
Brody Ross
Keagan Ryan
Tucker Saam
Joseph Sacco
Cade Sanders
Savannah Scarisbrick
Olsen Sccharfenberg
Ty Schlichting
John Schneider
Molly Schlissel
Mason Sellin
Adam Serne
Jacob Sexton
Collin Shaffer
Landen Shaffer
Jackson Shearer
William Sheehan
Addison (AB) Shouse
Nicole Skander
Oscar Skidmore
Cameron Smith
Colton Smith
Morgan Smith
Zed Solomon
Carson Spurgeon

Dylan Stalpes
Skylar Stanfield
Cody Stanford
Jacob Stavriotis
Jacob Steffen
BeaJae Steinecke
Callum Steinke
Lee Stokely
Ethan Stotz
Addyson Sullivan
Eva Tang
Kaleigh Tarsa
Carson Taylor
Kory Taylor
Eliel Thoma
Paul Thompson
Wyatt Thompson
Chloe Thornton
Grace Tischeafer
Landon Treague
Keegan Van Emmerik
Ryder Van Emmerik
Olivia Vandervest
Hilde Versluys
Zoe Versluys
Jaxon Vinson

Tabitha Wagner
David Walker
Morgan Rae Walker
Weston Walmsley
Connor Ward
Madalynn Washburn
Quinn Watkins
Jett Webb
Adalynn Weber
Clara Weber
Branden Wells
Noah White
Parker Whiting
Emory Williams
Xander Wisniewski
Wyatt Wojtas
Sly Wood
Gavin Wulf
Gage Yarborough
Landon Yocum
Aubrey Young
Jacob Wyatt Young
Savannah Young
Stella Young
Sydney Young
McKenzie Zampese





SILENCER
CENTRAL.

THE MOST TRUSTED WAY TO BUY SUPPRESSORS

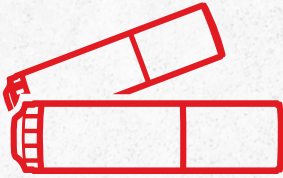

BUY FROM
HOME



FILE WITH
TRUST



RECEIVE WITH
CONFIDENCE

MOST POPULAR SUPPRESSORS UNDER \$600

**DEAD AIR
MASK 22**

\$459



**BANISH
HNT 30 SS &
VRMT 223 SS**

\$499



TO GET STARTED VISIT [SILENCERCENTRAL.COM](https://silencercentral.com)

SUPPRESSORS ORDERED FROM YOUR HOME AND DELIVERED TO YOUR DOOR.



CZ TS3 ORANGE

czfirearms.com | [f](#) [@](#) [X](#) [v](#)



CRAFTING EXCELLENCE

Every Day, every Day Hodgdon Powder delivers unmatched precision and performance for reloaders with a passion for the craft.



SHOOTING SPORTS SIMULATIONS

2025



COMPETITION

CIVIL DEFENSE

ENTERTAINMENT

HUNTER EDUCATION

LASER SHOT

Proud Sponsor of
The Scholastic
Shooting Sports
Foundation

YOUR NEXT LEVEL STARTS HERE

HUGE ARMS USA

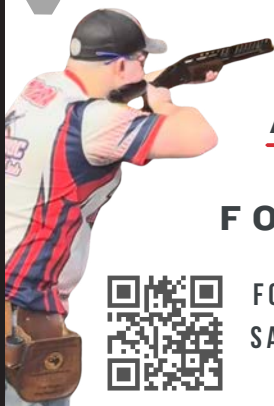

**PRICED FOR
ALL SHOOTERS
ENGINEERED
FOR ADJUSTABILITY**



FOR A DEALER NEAR YOU CONTACT:
SALES@APEXSHOOTINGSUPPLY.COM

717-553-1677

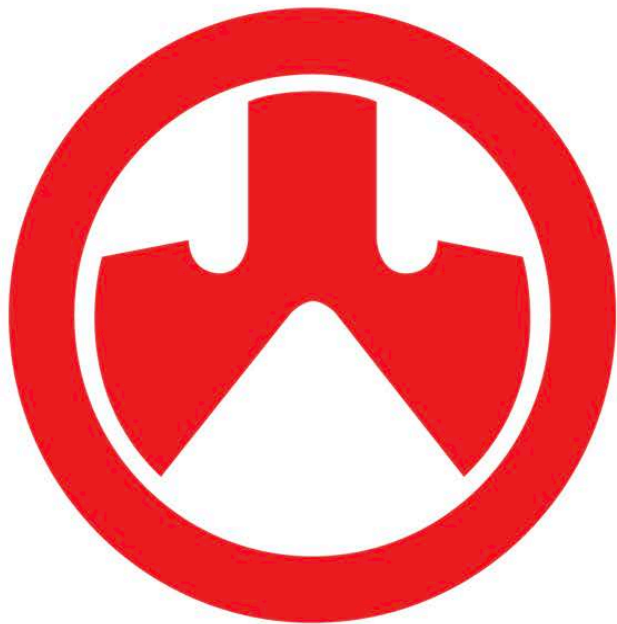

MAGPUL

TRUGLO[®] FIBER·OPTIC PRO

COMPETITION HANDGUN SIGHTS



Ultra-bright fiber-optic front sight for fast acquisition

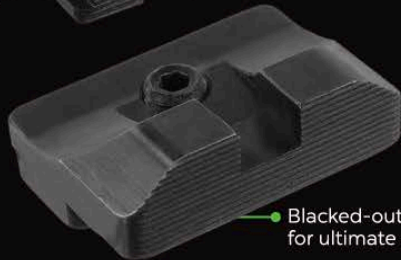

Blacked-out rear sight for ultimate contrast



WHEN BRIGHTNESS COUNTS[®]
VISIT TRUGLO.COM FOR CURRENT MODEL/COMPATIBILITY INFORMATION



CCI



RED WHITE & PEW

What's more American than the crack of a 22 and the ring of steel? The satisfaction of putting your name on the leaderboard and food on the table? CCI® makes it all happen with the best rimfire loads in every category—and we've been doing it since 1951.

Proudly made in the USA.



LEARN MORE AT
cci-ammunition.com

THE LEADER IN RIMFIRE AMMUNITION®



- **TRIGGER YOU CANNOT OUTFRONT**
- **PRECISION ABOVE YOUR EXPECTATIONS**
- **SUCCESS PROVEN AT THE OLYMPICS**

Pardini TR20 cal. 22LR

Semi-automatic competition rifle built for action shooters. In under two minutes with just two screws, convert it into the Olympic-dominating Pardini SP Pistol.

One gun. Two champions.

TR20



Celebrate the **250**th Birthday of the **USA** with

\$250 OFF TR20 ALL MODELS

Limited Time Offer (June 1 - July 30, 2026) While supplies last



For more information and details visit us

www.PardiniGuns.com

info@PardiniGuns.com

Bullseye, Olympic and Action conversion options are available for TR20. Kits sold separately.

HERE TO LEND A HAND. AND SO MUCH MORE.

Whether you need expertise on local real estate, a loan option that meets your needs, or a friendly ear to listen to your concerns, Rural 1st offers the resources and support you need to make your dream a possibility. Learn more at Rural1st.com.



Rural 1st is a tradename and Rural 1st, the Rolling Hills Window icon and Closer to What Matters are exclusive trademarks of Farm Credit Mid-America. NMLS 407249. Rural 1st products are available to consumers within the territories of participating Farm Credit System Associations.



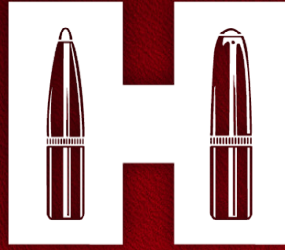

Hornady®

AMERICAN MADE.
American Owned.

Proudly made in Nebraska since 1949. Hornady began in a small garage with a simple goal, build better bullets. Driven by innovation, quality, and the hard work of Americans. Hornady has grown into a global leader, while staying true to its roots and the values that built it.



BULLETS • AMMUNITION • RELOADING • SECURITY

800-338-3220 | HORNADY.COM

**WORLD'S
LIGHTEST SEMI-
AUTO FIREARMS**



GOAT-15

**LIVE DEMOS
IN THE
PISTOL BAYS**

**MOUNTAIN BILLY
GUN LAB**



**THE
ULTIMATE
DOG
TRAVEL
SYSTEM**

RuffLand
PERFORMANCE KENNELS



**PROUDLY MADE IN THE USA
PRODUCTS.**

WWW.RUFFLANDKENNELS.COM



**SCAN THE QR CODE TO VIEW
CURRENT SSSF RAFFLES**



SCAN THE QR CODE TO VIEW
STANDINGS & RESULTS



SCTP



SASP

PTR

Since 2002, PTR has been committed to crafting reliable, accurate roller-delayed blowback firearms. Honoring an iconic legacy while advancing design through breakthrough technology, we pair tradition with modern innovation across our rifles, suppressors, and accessories.



IT'S ALREADY IN YOUR BLOOD
DON'T LET IT GET IN YOUR HEAD



Available at Retailers Now

HODGDON
THE BRAND THAT'S TRUE

913-362-9455 • hodgdonpowderco.com

TRAP • SKEET • SPORTING CLAYS • 5-STAND • PISTOL • RIFLE • INTERACTIVE HANDGUN RANGE • RETAIL STORE



DELAWARE, OHIO

Just 35 minutes from The Cardinal Center



Best of luck, shooters!

MAKE SURE YOUR TEAM IS READY WITH EXTRA PRACTICE TIME.

Trap and Skeet fields available on a first-come, first-served basis. Minimum of five shooters to a field. \$7 per round. One hour practice time limit will be enforced if other teams are waiting. Feel free to get back in line.

PROUD TO BE THE
OFFICIAL PRACTICE CENTER
FOR THE
SCTP NATIONAL CHAMPIONSHIPS

A portion of all target proceeds will be donated to the SCTP Scholarship Fund!

3722 MARYSVILLE RD. DELAWARE, OH | 740.363.7555 | WWW.BLACKWINGSC.COM | FOLLOW US:  

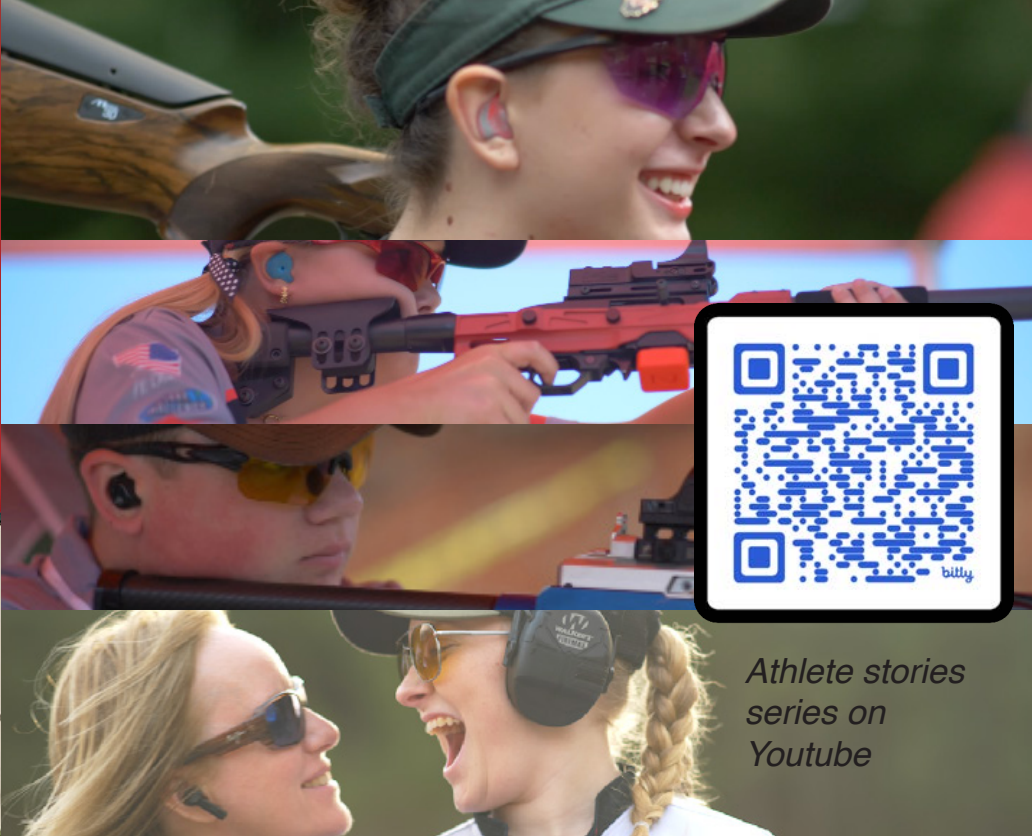

*Athlete stories
series on
Youtube*

PROUD SPONSOR OF SCTP



COLE
FINE GUNS & GUNSMITHING

Keep All Your European Shotguns in Perfect Condition with
Annual Service from Cole Fine Guns and Gunsmithing
Schedule an Annual Service Today at www.colegun.com

WITH SPECIAL GUEST



TIM WARD GUNSMITHING



Building #C, Units C11 & C12



DUCKS UNLIMITED.

Supports Youth Shooting Sports

TEAM RESOURCE ASSISTANCE PROGRAM

DU T.R.A.P. provides discounted merchandise and professionally designed marketing and fundraising materials for official youth shooting teams. DU

guarantees all net revenues earned stay with the participating team for immediate use. Take advantage of this opportunity today by visiting www.ducks.org/TRAP.

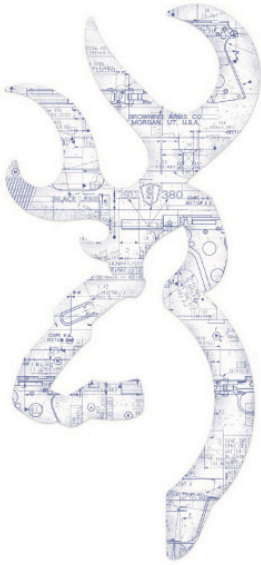

BLUEPRINT FOR SUCCESS.



*Black Label
1911-380 Medallion Pro
Full-Size*

browning.com



Year's Supply.



Day's Supply.

No one connects you to more firearms and accessories than GunBroker.com. Whatever kind of gun buyer you are, GunBroker.com is your kind of auction site. The world's largest online auction for every type of firearm enthusiast.

GUN
BROKER.COM

Going. Going. Gun.™

Cardinal
shooting Center



2026 Trap Events

August 11-16th: Cardinal Classic

September 11-13th: Freedom Fall Classic

October 2-4th: ACUI/SCTP Collegiate

Watch our website for pre-squad information

www.thecardinalcenter.com

GUNS UNLIMITED

EXCLUSIVES



MONTE CARLO ADJ COMB ADJ COMB/GRACOIL

825 TRAP COMBOS

WITH HARD CASE
ADJUSTABLE RIB ON THE
UN SINGLE BBL ONLY

30"/32" 30"/34" 32"/34"

NEW!



NEW! 825 TRAP UNSINGLE

32" OR 34" BARREL

MONTE CARLO ADJ COMB ADJ COMB/GRACOIL



MONTE CARLO ADJ COMB ADJ COMB/GRACOIL

725 TRAP COMBOS

WITH HARD CASE
ADJUSTABLE RIB ON THE
UN SINGLE BBL ONLY

30"/32" 30"/34" 32"/34"



725 ADJUSTABLE RIB TRAP COMBOS

WITH HARD CASE
ADJUSTABLE RIB ON THE UN SINGLE & O/U BBL



MONTE CARLO
ADJ COMB
ADJ COMB/GRACOIL



MONTE CARLO
ADJ COMB
ADJ COMB/GRACOIL

RIGHT & LEFT AVAILABLE
WALNUT & MAPLE

30"/32" 30"/34" 32"/34"

INCLUDES 5 EXTENDED INVECTOR DS CHOKES

725 TRAP UNSINGLE

32" OR 34" BARREL

MONTE CARLO ADJ COMB ADJ COMB/GRACOIL



CITORI UNIVERSAL HI POST ADJUSTABLE RIB



12 GAUGE ONLY
WALNUT & MAPLE
30" OR 32" BARREL
MIDAS CHOKE TUBES

CITORI SPECIAL SPORTING HI POST ADJUSTABLE RIB



FIXED ADJ COMB ADJ COMB/GRACOIL

GUNS UNLIMITED

4325 S. 120th Street • Omaha, NE 68137 • PH 402-339-0771 • FAX 402-330-8029

sales@gunsunlimitedomaha.com

Subject To Stock On Hand • Signed & Current FFL Required
Business & Personal Checks Held 14 Days • Certified Funds & Credit Card Orders Same Day





DawsonEnt.com

STEALTH PLATE



Invisible Adjustable Butt

StealthPlatePro.com



Stock Lock

StockLockSystem.com



ADVANCED HEARING PROTECTION

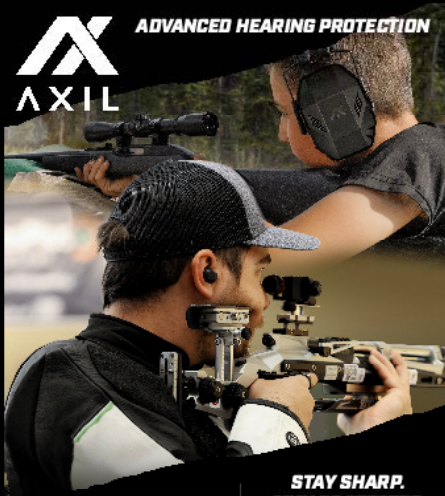

AXIL IS A PROUD SPONSOR OF:



STAY SHARP.
STAY PROTECTED.
BE AXIL AWARE.



goAXIL.com

WINCHESTER
SAFES

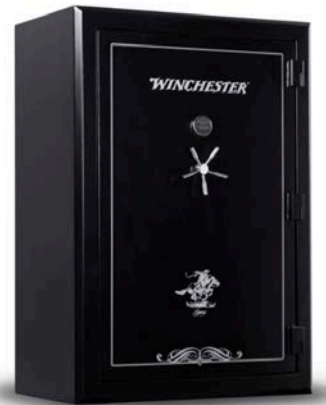

Safe responsible handling
of firearms includes safe
responsible storage.



Baron
Engraving

Expert engraving By design

Baron Engraving is the premiere custom engraving and finishing company. For nearly 40 years Baron Artisans have blended old-world craftsmanship with leading engraving technologies to transform ordinary surfaces into works of art.

<https://www.baronengraving.com>



SSSF NATIONALS FUNDRAISING EVENT

All proceeds from this event will be equally split between
the SSSF Scholarship Fund and the SSSF Forever Fund

Suppressor raffles will be drawn daily. Gun auction ends July 19th, 2026 at 8:00 p.m. Central time



3 certificates for a SILENCER CENTRAL Suppressor will be raffled each day
Only 50 \$10.00 tickets for each suppressor will be sold



GUNS OF NATIONALS ONLINE AUCTION



BID EARLY & OFTEN - IT'S FOR THE KIDS!



Winners do not need to be present to win. Winners will be posted on SSSF website. Winners will be contacted by phone or email. Prizes will be shipped. Gun winners not able to lawfully receive their prize in their state will receive \$200.00 in lieu of the prize. No other trades or cash value alternatives. If you may not have a suppressor in your state, please do not purchase tickets for the suppressor raffle. Prizes not claimed within 60 days of drawing are forfeited. SSSF, 3218 Fannin Rd #1060, Melissa, TX 75454



Join us at the SSSF's venue, Prairie Grove Shooting Sports Complex, located in Columbia, MO just off I-70! Shoot on over 140 acres in a beautiful park setting. Our full-facility offers a spacious clubhouse, Golf cart rentals, pistol/rifle berms, American skeet, American trap, trap doubles, modified international trap, Bunker trap, two five-stand facilities, and three sporting clays courses offering 48+ shooting stations.



1420 County Road 276, Columbia, MO 65202

107 **573-387-4747**

Help us ensure the future of Youth Shooting Sports FOREVER!

Support the SSSF Forever Fund with your

\$10 DONATION

Receive a Precious Metals Shirt
or SSSF Shooting Towel



\$25 DONATION

Receive a SSSF Tumbler
or SSSF Hat



Visit the SASP or SCTP Registration Building to make your donation and help us reach our \$40 Million Goal!

SSSF SCHOLARSHIPS FUEL THE NEXT GENERATION



Since 2013, the Scholastic Shooting Sports Foundation has awarded over \$1,344,500 in scholarship funds benefiting over 1,450 student athletes, from nearly all 50 states in the Scholastic Clay Target and Scholastic Action Shooting programs.

We are pleased to announce that the SSSF has awarded \$120,000 in scholarships so far in 2026.

Scan to support the SSSF Scholarship Fund for next year's graduates!





Take Aim

TECHNOLOGIES



IT'S LIKE HAVING A COACH ON YOUR GUN

Take Aim is proud to support



All SCTP members can get **10%** off of their ShotTracker purchases for 2 to 4 units with the coupon code **10SCTP25**

For purchases of 5 or more ShotTracker units use coupon code **15SCTP** for a 15% discount.

ADD TO CART



SWITCH TO



PATRIOT MOBILE

Mobilizing Freedom®

AMERICA'S ONLY

CHRISTIAN CONSERVATIVE WIRELESS PROVIDER

FREE MONTH

USE PROMO CODE

SSSF

